

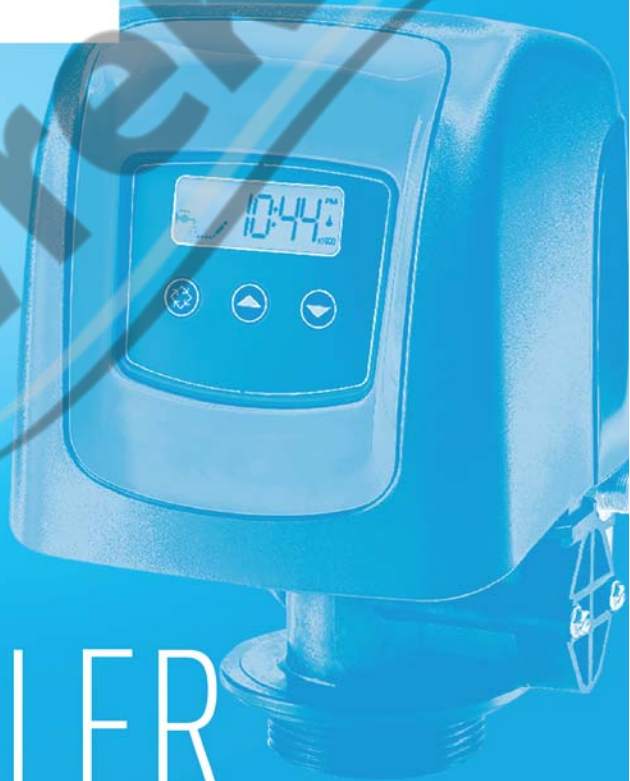

**FLECK
5800 SXT**



INSTALLER MANUAL

Table of content

1.	Generalities	7
1.1.	Scope of the documentation	7
1.2.	Release management	7
1.3.	Manufacturer identifier, product	7
1.4.	Intended use	7
1.5.	Abbreviations used	8
1.6.	Norms	8
1.6.1.	Applicable norms	8
1.6.2.	Available certificates	8
1.7.	Procedure for technical support	9
1.8.	Copyright	9
1.9.	Limitation of liability	9
2.	Safety	10
2.1.	Safety pictograms definition	10
2.2.	Safety tags location	10
2.3.	Hazards	10
2.3.1.	Personnel	11
2.3.2.	Material	11
2.4.	Hygiene and sanitization	11
2.4.1.	Sanitary issues	11
2.4.2.	Hygiene measures	11
3.	Description	12
3.1.	Technical specifications	12
3.1.1.	Performance flow rate characteristics	13
3.2.	Outline drawing	14
3.3.	Description and components location	15
3.4.	System regeneration cycle	16
3.4.1.	Downflow regeneration cycle (5-cycles operation)	16
3.4.2.	Upflow regeneration cycle (5-cycles operation)	18
3.4.3.	Upflow fill first regeneration cycle (5-cycles operation)	20
3.4.4.	Filter cycle (3-cycles operation)	22
3.5.	Configurations for downflow softener, upflow softener and filter	23
3.5.1.	Downflow softener	23
3.5.2.	Upflow softener	23
3.5.3.	Filter	23
3.6.	Options available on the valve	24

4.	System sizing	25
4.1.	Recommendations	25
4.1.1.	Injector/DLFC/BLFC-Valve configuration	25
4.2.	Sizing a softener (single unit)	25
4.2.1.	Parameters to be considered.	25
4.2.2.	Determining the required volume of resin	27
4.2.3.	Resin exchange capacity and capacity of the unit	27
4.2.4.	Valve configuration	29
4.2.5.	Cycle time calculation.	30
4.3.	Salt amount definition	32
4.4.	1650 Injector flow rates	33
5.	Installation	36
5.1.	Warnings	36
5.2.	Safety notices for installation	36
5.3.	Installation environment	36
5.3.1.	General.	36
5.3.2.	Water	37
5.3.3.	Electrical	37
5.3.4.	Mechanical.	37
5.4.	Integration constraints	38
5.5.	Valve connection to piping	38
5.5.1.	Top-mounted valve installation	39
5.6.	Block diagram and configuration example	41
5.7.	Regeneration types	42
5.8.	Electrical connections	42
5.9.	By-passing	43
5.10.	Drain line connection	44
5.11.	Overflow line connection	45
5.12.	Brine line connection	45
6.	Programming	46
6.1.	Display	46
6.2.	Commands	47
6.3.	Setting the time of the day (TD)	47
6.4.	Basic programming	47

6.4.1.	Day of Override (DO)	47
6.4.2.	Regeneration time (RT)	48
6.4.3.	Feed Water Hardness (H)	48
6.4.4.	Reserve capacity (RC) or (SF)	48
6.4.5.	Current day of the week (CD)	48
6.5.	Master programming mode	49
6.5.1.	Master programming mode chart	49
6.5.2.	Entering master programming mode	52
6.5.3.	Display format mode (DF)	52
6.5.4.	Valve type (VT)	52
6.5.5.	Regeneration flow (RF)	52
6.5.6.	Regeneration control type (CT)	53
6.5.7.	Unit capacity (C)	53
6.5.8.	Filter capacity (V)	53
6.5.9.	Feedwater hardness (H)	54
6.5.10.	Reserve selection (RS)	54
6.5.11.	Days override (DO)	55
6.5.12.	Regeneration time (RT)	56
6.5.13.	Regeneration cycle step duration	56
6.5.14.	Day of week (Dn, n = 1 to 7)	57
6.5.15.	Current day (CD)	57
6.5.16.	Flow meter type (FM)	58
6.5.17.	Meter pulse (K)	58
6.5.18.	Time based relay setting (RE)	58
6.5.19.	Flow based relay setting (VR)	59
6.6.	Filter programming	60
6.7.	Diagnostic	61
6.7.1.	Commands	61
6.7.2.	Current flow rate (FR)	61
6.7.3.	Peak flow rate (PF)	61
6.7.4.	Hours since last regeneration (HR)	61
6.7.5.	Volume since last regeneration (VU)	62
6.7.6.	Reserve capacity (RC)	62
6.7.7.	Totalizer (TV)	62
6.7.8.	Software version (SV)	62
6.8.	Resetting the controller	63
6.8.1.	Soft reset (SR)	63
6.8.2.	Hard reset (HR)	63

7.	Commissioning	64
7.1.	Water filling, draining and waterproofness inspection	64
7.1.1.	Activating the softener	64
7.1.2.	Additional tips	65
7.2.	Sanitization	65
7.2.1.	Disinfection of water softeners	65
7.2.2.	Sodium or calcium hypochlorite	65
7.2.3.	Electro chlorination.	66
8.	Operation	67
8.1.	Display during operation	67
8.1.1.	During regeneration	67
8.2.	Recommendations	67
8.3.	Manual regeneration	68
8.3.1.	Manual delayed regeneration	68
8.3.2.	Immediate regeneration	68
8.3.3.	To advance regeneration cycles	68
8.4.	Operation during a power failure	68
9.	Maintenance	69
9.1.	Recommendations	69
9.1.1.	Use original spare parts	69
9.1.2.	Use original approved lubricants	69
9.1.3.	Maintenance instructions	69
9.2.	Cleaning and maintenance	69
9.2.1.	Cleaning and maintenance	69
9.2.2.	Replacing the controller	70
9.2.3.	Replacing the controller motor	71
9.2.4.	Replacing the gearing system	72
9.2.5.	Replacing the piston and/or the brine valve	73
9.2.6.	Replacing the seals and spacers cartridge	74
9.2.7.	Cleaning the injector	75
9.2.8.	Replacing the optical sensor	76

10.	Troubleshooting	77
10.1.	Error detection	79
10.2.	Error types and causes	79
10.2.1.	Motor stall / cam sense error	79
10.2.2.	Motor run-ON error / cycle sense error	79
10.2.3.	Regeneration failure	80
10.2.4.	Memory error	80
10.2.5.	Fail safe error	80
11.	Spare parts	81
11.1.	Plastic turbine meter assembly	81
11.2.	Valve parts list	82
11.3.	Power head parts list	84
11.4.	Bypass valve assembly list	85
11.4.1.	Plastic bypass (no yoke)	85
11.4.2.	1" BSP female stainless steel bypass	86
11.5.	Safety brine valve	88
11.6.	Safety brine valves list	89
12.	Scrapping	90

1. Generalities

1.1. Scope of the documentation

The documentation provides the necessary information for appropriate use of the product. It informs the user to ensure efficient execution of the installation, operation or maintenance procedures.

The content of this document is based on the information available at the time of publication. The original version of the document was written in English.

For safety and environmental protection reasons, the safety instructions given in this documentation must be strictly followed.

This manual is a reference and will not include every system installation situation. The person installing this equipment should have:

- Training in the Fleck series, SXT controllers and water softener installation;
- Knowledge of water conditioning and how to determine proper controller settings;
- Basic plumbing skills.

This document is available in other languages on www.pentairaquaeurope.com/product-finder/product-type/control-valves.

1.2. Release management

Revision	Date	Author	Description
A	18.04.2017	BRY	First edition

1.3. Manufacturer identifier, product

Manufacturer: Pentair Manufacturing Italy Srl
 Via Masaccio, 13
 56010 Lugnano di Vicopisano (PI) – Italy

Product: Fleck 5800 - SXT

1.4. Intended use

The device is intended to be used for domestic applications only and it is purpose-built for water treatment.

1.5. Abbreviations used

DF.....	Down Flow
UF.....	Up Flow
HW.....	Hot Water
Inj.....	Injector
DLFC.....	Drain Line Flow Controller
BLFC / Refill Flow Controller.....	Brine Line Flow Controller
QC.....	Quick Connect
Regen.....	Regeneration
S&S.....	Seals & Spacers
BV.....	Brine Valve
SBV.....	Safety Brine Valve
TC.....	Time Clock

1.6. Norms

1.6.1. Applicable norms

Comply with the following guidelines:

- DM174: "Regulation of materials and objects that can be used in stationary collection, treatment, supply and distribution of water intended for human consumption.";
- 2006/42/EC: Machinery Directive;
- 2014/35/UE: Low Voltage Directive;
- 2014/30/UE: Electromagnetic compatibility;
- 2011/65/CE: Restriction of use of certain hazardous substances in electrical and electronic equipment (RoHS);
- UNI EN ISO9001 (certificate no. 95.022 SSG ICS).

Meets the following technical standards:

- EN 55014-1;
- EN 55014-2;
- EN 61000-6-1;
- EN 61000-6-2;
- EN 61000-6-3;
- EN 61000-6-4;
- EN 61010-1.

1.6.2. Available certificates

- | | |
|---|---|
| <ul style="list-style-type: none"> • CE • DM174 | <ul style="list-style-type: none"> • ACS |
|---|---|

Access to all certifications:



1.7. Procedure for technical support

Procedure to follow for any technical support request:

- A** Collect the required information for a technical assistance request.
 - Product identification (see 2.2. Safety tags location, page 10 and 9.1. Recommendations, page 69);
 - Problem description of the device.
- B** Please refer to the "Troubleshooting" chapter, page 75. If the problem persists contact your supplier.

1.8. Copyright

© 2016 Pentair International Srl All rights reserved.

1.9. Limitation of liability

Pentair Quality System EMEA products benefit, under specific conditions, from a manufacturer warranty that may be invoked by Pentair's direct customers. Users should contact the vendor of this product for applicable conditions and in case of a potential warranty claim.

Any warranty provided by Pentair regarding the product will become invalid in case of:

- Improper installation, improper programming, improper use, improper operation and/or maintenance leading to any kind of product damages;
- Improper or unauthorized intervention on the controller or components;
- Incorrect, improper or wrong connection/assembly of systems or products with this product and vice versa;
- Use of a non-compatible lubricant, grease or chemicals of any type and not listed by the manufacturer as compatible for the product;
- Failure due to wrong configuration and/or sizing.

Pentair accepts no liability for equipment installed by the user upstream or downstream of Pentair products, as well as for process/production processes which are installed and connected around or even related to the installation. Disturbances, failures, direct or indirect damages that are caused by such equipment or processes are also excluded from the warranty. Pentair shall not accept any liability for any loss or damage of profits, revenues, use, production, or contracts, or for any indirect, special or consequential loss or damage whatsoever. Please refer to the Pentair List Price to know more about terms and conditions applicable to this product.

2. Safety

2.1. Safety pictograms definition



Caution

Warns of a risk of minor injury or major material damage to the device or environment.



Warning

Warns against serious personal injury and damage to health.



Danger

Warns against serious personal injury or death.



Mandatory

Standard or measure to apply.



Note

Comment



Prohibition

Restriction to be observed.

2.2. Safety tags location

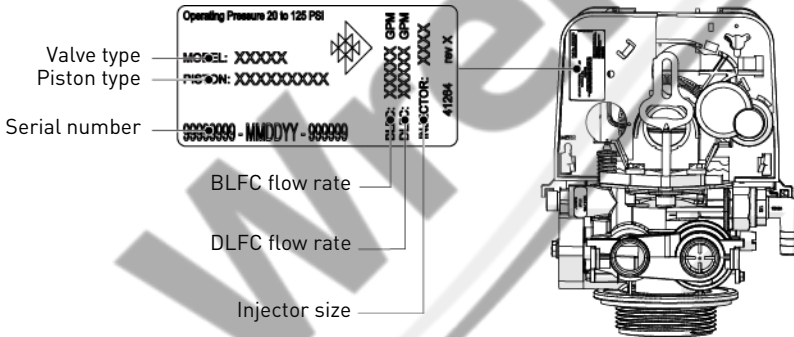

Note

Ensure that the safety tags on the device are completely legible and clean. If necessary, replace them with new tags and put them in the same places.

2.3. Hazards

All the safety and protection instructions contained in this document must be observed in order to avoid temporary or permanent injury, damage to property or environmental pollution.

At the same time, any other legal regulations, accident prevention and environmental protection measures, as well as any recognized technical regulations relating to appropriate and risk-free methods of working which apply in the country and place of use of the device must be adhered to.

Any non-observation of the safety and protection rules, as well as any existing legal and technical regulations, will result in a risk of temporary or permanent injury, damage to property or environmental pollution.

2.3.1. Personnel

Only qualified and professional personnel, based on their training, experience and instruction as well as their knowledge of the regulations, the safety rules and operations performed, are authorized to carry out necessary work.

2.3.2. Material

The following points must be observed to ensure proper operation of the system and the safety of user:

- Be careful of high voltages present on the transformer (100 - 240 V).
- Do not put your fingers in the system (risk of injuries with moving parts and shock due to electric voltage).

2.4. Hygiene and sanitization

2.4.1. Sanitary issues

Preliminary checks and storage

- Check the integrity of the packaging. Check that there is no damage and no signs of contact with liquid to make sure that no external contamination occurred.
- The packaging has a protective function and must be removed just before installation. For transportation and storage appropriate measures should be adopted to prevent the contamination of materials or objects themselves.

Assembly

- Assemble only with components which are in accordance with drinking water standards.
- After installation and before use, perform one or more manual regenerations in order to clean the media bed. During such operations, do not use the water for human consumption. Perform a disinfection of the system in the case of installations for treatment of drinking water for human use.



Note

This operation must be repeated in the case of ordinary and extraordinary maintenance. It should also be repeated whenever the system remains idle for a significant time.

2.4.2. Hygiene measures

Disinfection

- The materials used for the construction of our products meet the standards for use with potable water; the manufacturing processes are also geared to preserving these criteria. However, the process of production, distribution, assembly and installation, may create conditions of bacterial proliferation, which may lead to odor problems and water contamination.
- It is therefore strongly recommended to sanitize the products. See 7.2. Sanitization, page 65.
- Maximum cleanliness is recommended during the assembly and installation.
- For disinfection, use Sodium or Calcium Hypochlorite and perform a manual regeneration.

3. Description

3.1. Technical specifications

Design specifications/ratings

Valve body	Fiber-reinforced polymer
Rubber components	EP / EPDM / Silicon
Valve material certification	DM174, ACS, CE
Weight (valve with controller)	2 kg (max)
Recommended operating pressure	1.4 - 8.6 bar
Maximum inlet pressure	8.6 bar
Hydrostatic test pressure.....	20 bar
Water temperature.....	1 - 43°C
Ambient temperature.....	5 - 40°C

Flow rates (3.5 bar inlet - valve only)

Continuous ($\Delta p = 1$ bar)	4.7 m ³ /h
Peak ($\Delta p = 1.7$ bar).....	6.1 m ³ /h
Cv*	5.4 gpm
Kv*	4.67 m ³ /h
Maximum backwash ($\Delta p = 1.8$ bar)	3.8 m ³ /h

*Cv : Flow rate in gpm across the valve at a pressure drop of 1 psi at 60°F.
 *Kv : Flow rate in m³/h across the valve at a pressure drop of 1 bar at 16°C.

Valve connections

Tank Thread.....	2½" - 8NPSM
Inlet/Outlet.....	¾" or 1"
Riser tube	26.7 mm O.D., 1.05" tube
Drain line	½" O.D.
Brine line (1650).....	¾"

Electrical

Transformer input voltage	100 to 240 VAC
Input supply frequency	50 to 60 Hz
Transformer output voltage	12 VDC
Motor input voltage.....	12 VDC
Controller input voltage	12 VDC
Controller max. power consumption	6 W
Protection rating.....	IP 22
Power supply	100 to 240 VAC, 50/60 Hz, 0.5 A, Class II
Transient overvoltages	within the limits of category II
Pollution Degree.....	3

Temporary overvoltages must be limited in duration and in frequency.

Environmental conditions

- Indoor use only;
- Temperature from 5°C to 40°C;
- Maximum relative humidity 80% for temperatures up to 31°C decreasing linearly to 50% relative humidity at 40°C;
- Mains supply voltage fluctuations up to ±10% of the nominal voltage.

3.1.1. Performance flow rate characteristics

The graph shows the pressure drop created by the valve itself at different flow rates. It allows to predetermine the maximum flow rate going through the valve depending on the system settings (inlet pressure etc). It also allows to determine the valve pressure drop at a given flow rate, and therefore to evaluate the system pressure drop vs flow rate.

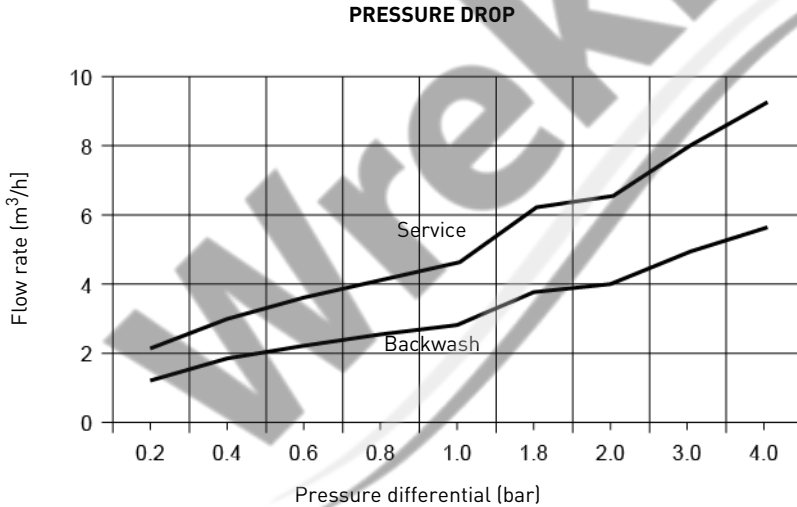

3.2. Outline drawing

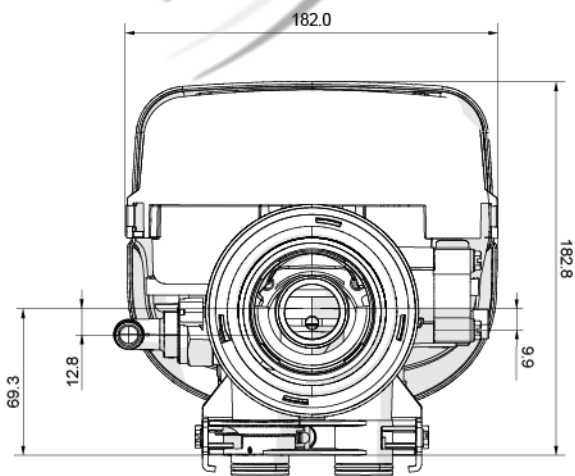
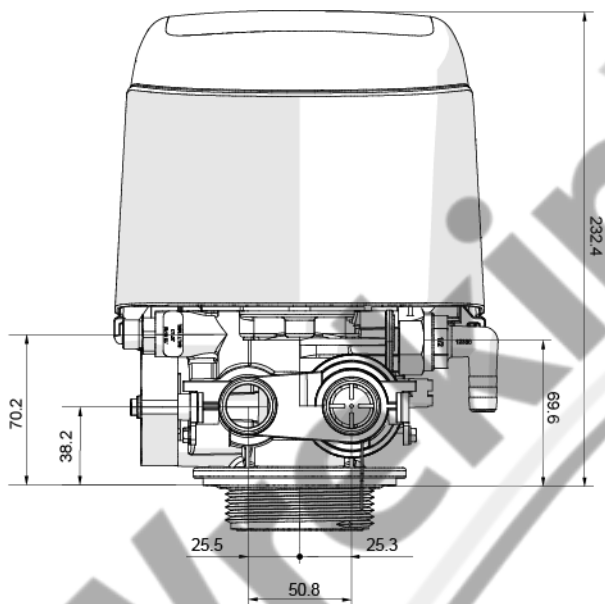

3.3. Description and components location

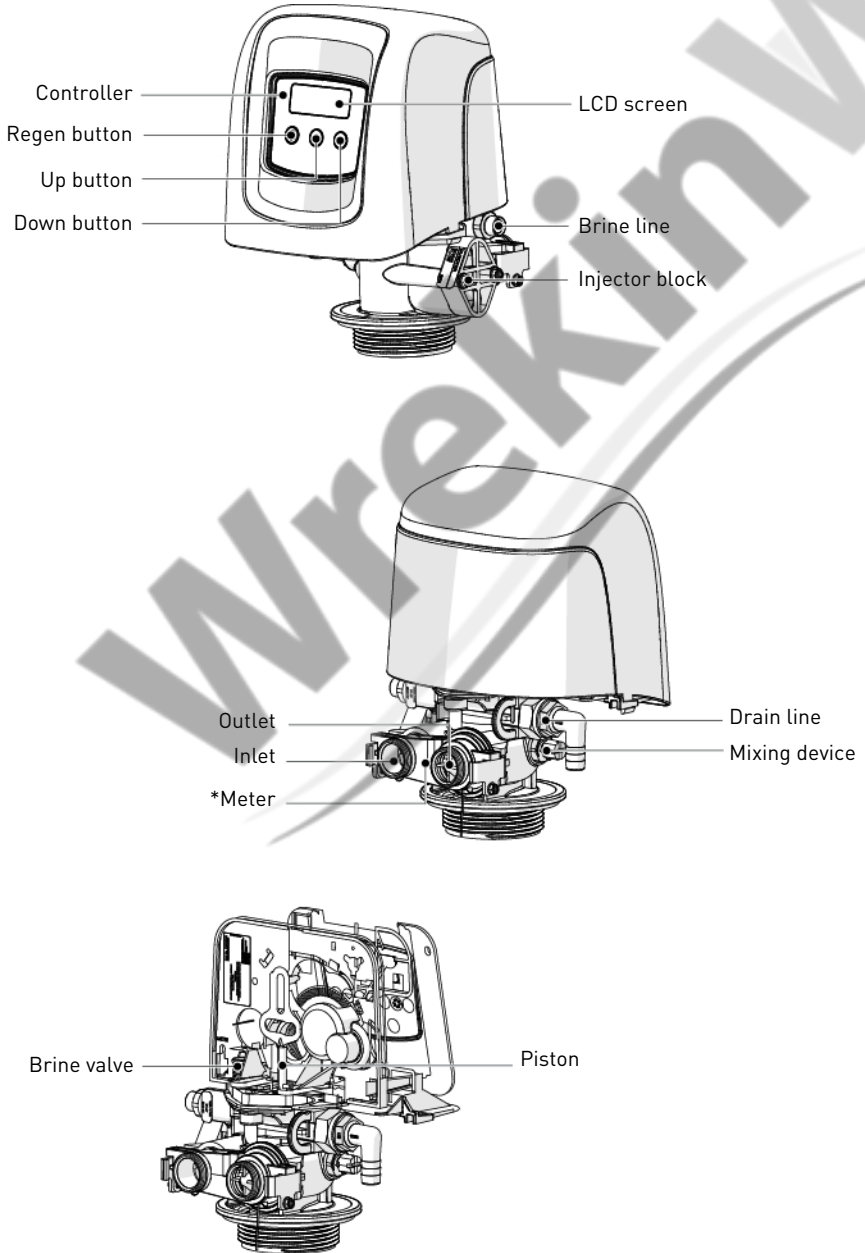

*Not included in case of timeclock

3.4. System regeneration cycle

**Note**

This valve allows to do down flow or up flow regenerations.

3.4.1. Downflow regeneration cycle (5-cycles operation)

Service — normal use

Untreated water is directed down through the resin bed and up through the riser tube. The hardness ions attach themselves to the resin and are removed from the raw water being exchanged on the resin beads against sodium ions. The water is conditioned as it passes through the resin bed.

Backwash — cycle C1

The flow of water is reversed by the valve and directed down the riser tube and up through the resin bed. During the backwash cycle, the bed is expanded and debris is flushed to the drain, while the media bed is remixed.

Brine draw & slow rinse — cycle C2

The controller directs water through the brine injector and brine is drawn from the brine tank. The brine is then directed down through the resin bed and up through the riser tube to the drain. The hardness ions on the resin beads are replaced by sodium ions and are sent to the drain. The resin is regenerated during the brine cycle. Afterwards the slow rinse phase starts.

Rapid rinse — cycle C3

The valve directs water down through the resin bed and up through the riser tube to the drain. Any residual brine is rinsed from the resin bed, while the media bed is recompact.

Brine tank refill — cycle C4

Water is directed to the brine tank, at a rate controlled by the refill controller [BLFC], to create brine for the next regeneration. During brine refill, treated water is already available at the valve outlet.



Note

For illustration purpose only. Always verify inlet and outlet marking on the valve.

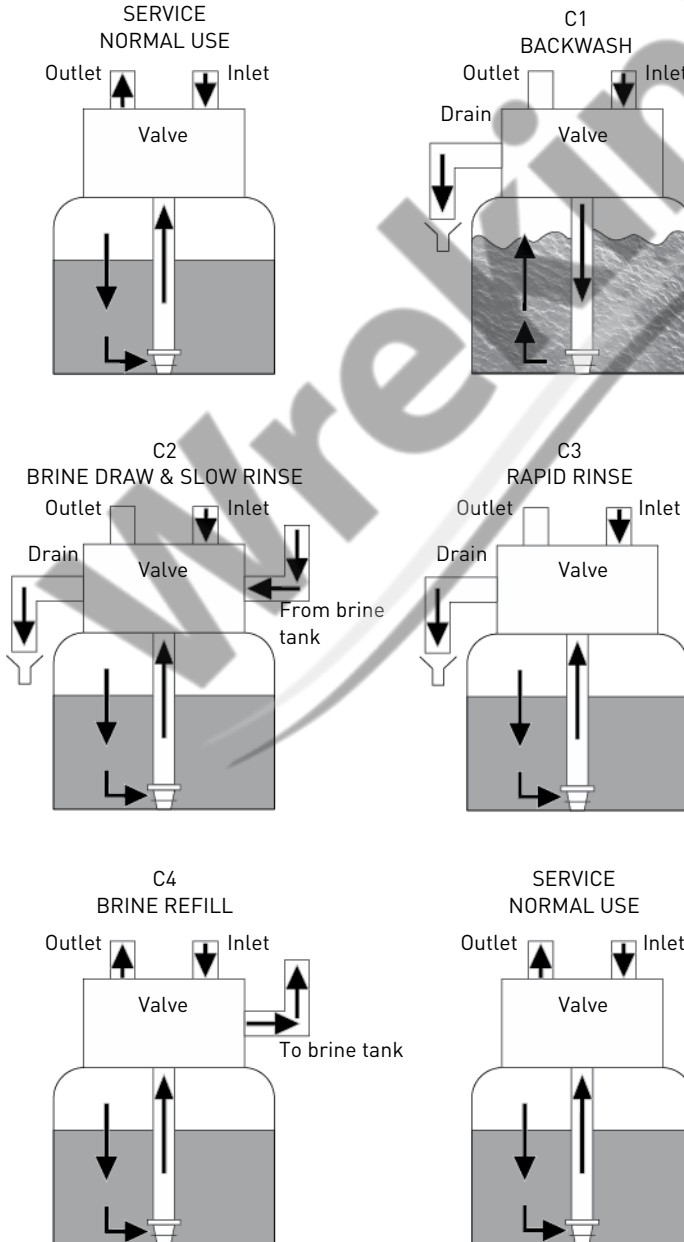

3.4.2. Upflow regeneration cycle (5-cycles operation)

Service — normal use

Untreated water is directed down through the resin bed and up through the riser tube. The hardness ions attach themselves to the resin and are removed from the raw water being exchanged on the resin beads against sodium ions. The water is conditioned as it passes through the resin bed.

Brine draw & slow rinse — cycle C1

The controller directs water through the brine injector and brine is drawn from the brine tank. The brine is then directed down through the riser tube and up through the resin bed to the drain. The hardness ions are replaced by sodium ions and are sent to the drain. The resin is regenerated during the brine cycle. Then the slow rinse phase starts.

Backwash — cycle C2

The flow of water is reversed by the valve and directed down the riser tube and up through the resin bed. During the backwash cycle, the bed is expanded and debris is flushed to the drain, while the media bed is remixed.

Rapid rinse — cycle C3

The controller valve directs water down through the resin bed and up through the riser tube to the drain. Any residual brine is rinsed from the resin bed, while the media bed is recompact.

Brine tank refill — cycle C4

Water is directed to the brine tank, at a rate controlled by the refill controller [BLFC], to create brine for the next regeneration. During brine refill, treated water is already available at the valve outlet.



Note

For illustration purpose only. Always check for inlet and outlet marking on the valve.

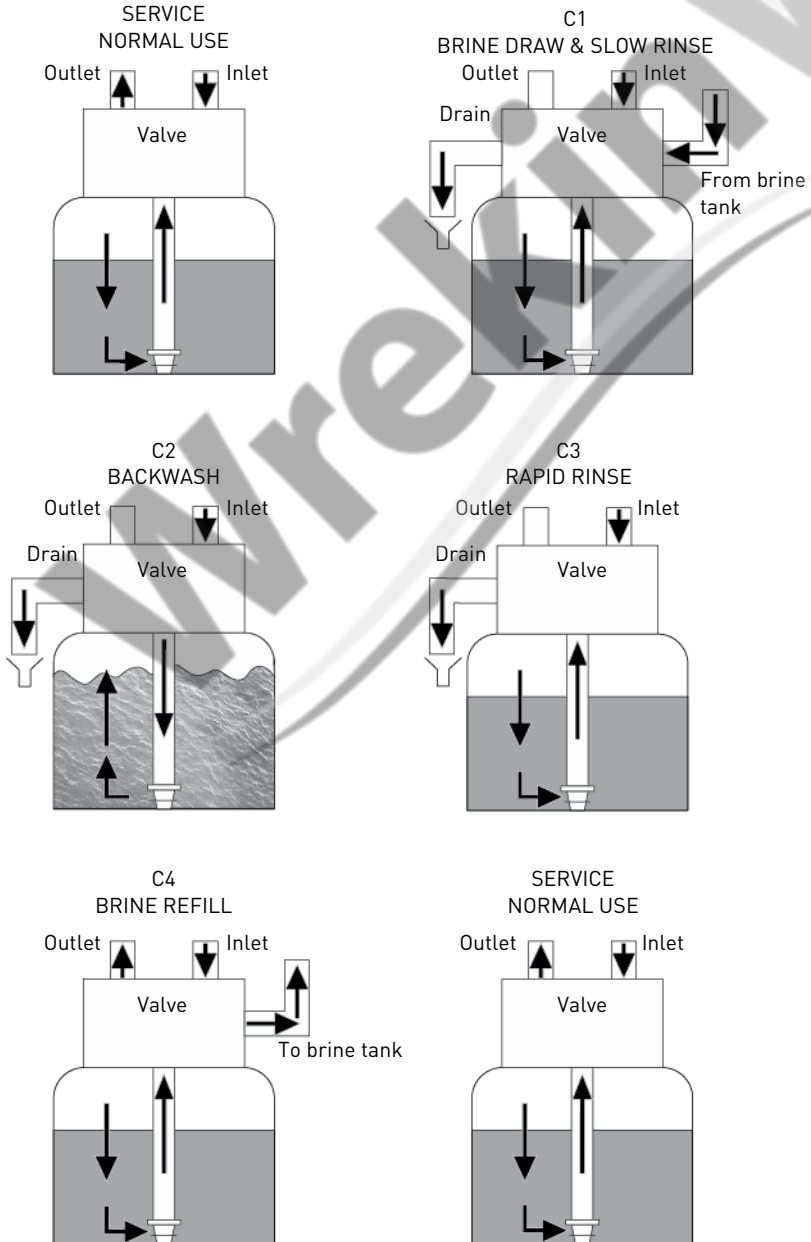

3.4.3. Upflow fill first regeneration cycle (5-cycles operation)

Service — normal use

Untreated water is directed down through the resin bed and up through the riser tube. The hardness ions attach themselves to the resin and are removed from the raw water being exchanged on the resin beads against sodium ions. The water is conditioned as it passes through the resin bed.

Brine tank refill — cycle C1

Water is directed to the brine tank, at a rate controlled by the refill controller [BLFC], to create brine for the next regeneration. During brine refill, treated water is already available at the valve outlet.

Brine draw & slow rinse — cycle C2

The controller directs water through the brine injector and brine is drawn from the brine tank. The brine is then directed down through the riser tube and up through the resin bed to the drain. The hardness ions are replaced by sodium ions and are sent to the drain. The resin is regenerated during the brine cycle. Then the slow rinse phase starts.

Backwash — cycle C3

The flow of water is reversed by the valve and directed down the riser tube and up through the resin bed. During the backwash cycle, the bed is expanded and debris is flushed to the drain, while the media bed is remixed.

Rapid rinse — cycle C4

The controller valve directs water down through the resin bed and up through the riser tube to the drain. Any residual brine is rinsed from the resin bed, while the media bed is recompact.



Note

For illustration purpose only. Always check for inlet and outlet marking on the valve.

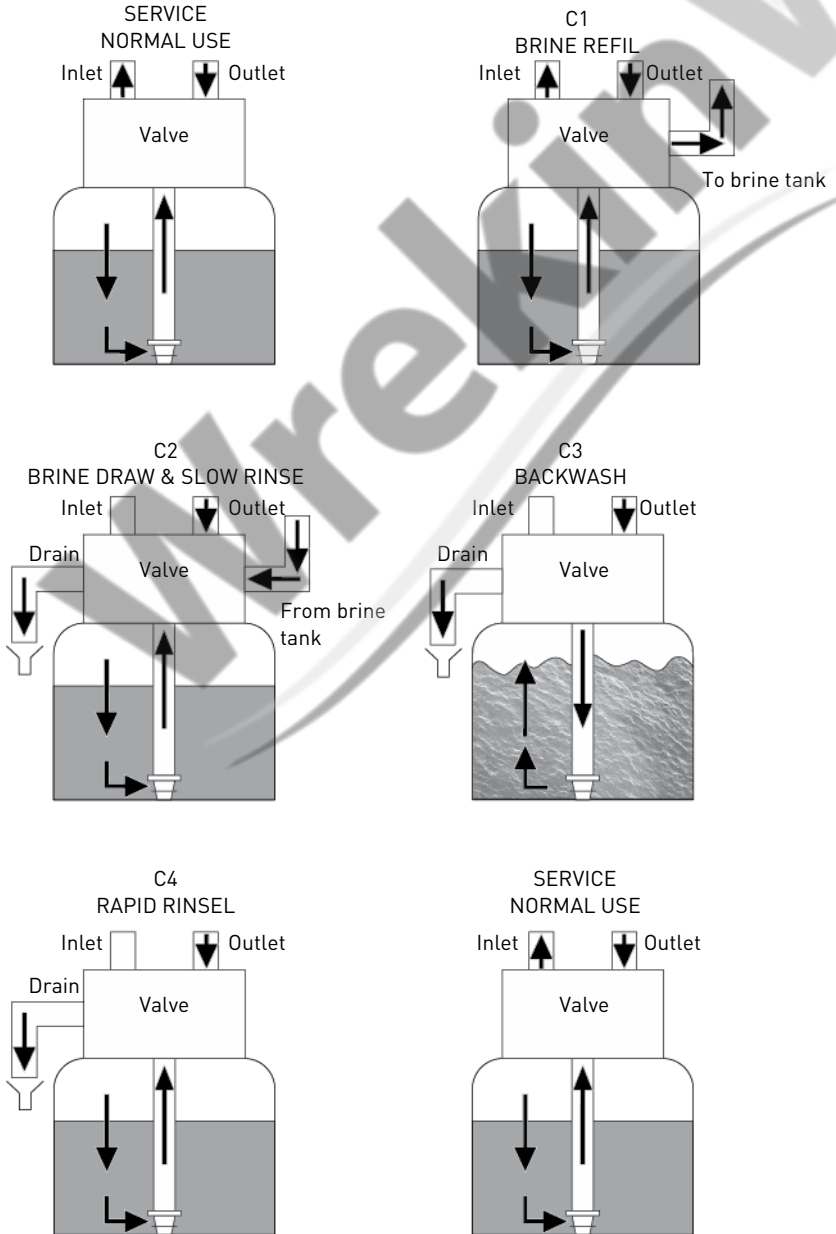

3.4.4. Filter cycle (3-cycles operation)

Service — normal use

Untreated water is directed down through the media and up through the riser tube. The impurities are retained by the media. The water is filtered as it passes through the media.

Backwash — cycle C1

The flow of water is reversed by the valve and directed down through the riser tube and up through the media. During the backwash cycle, the media is expanded and debris is flushed to the drain.

Rapid rinse — cycle C2

The valve directs water down through the media and up through the riser tube to the drain. The media is recompact.



Note

For illustration purpose only. Always verify inlet and outlet marking on the valve.

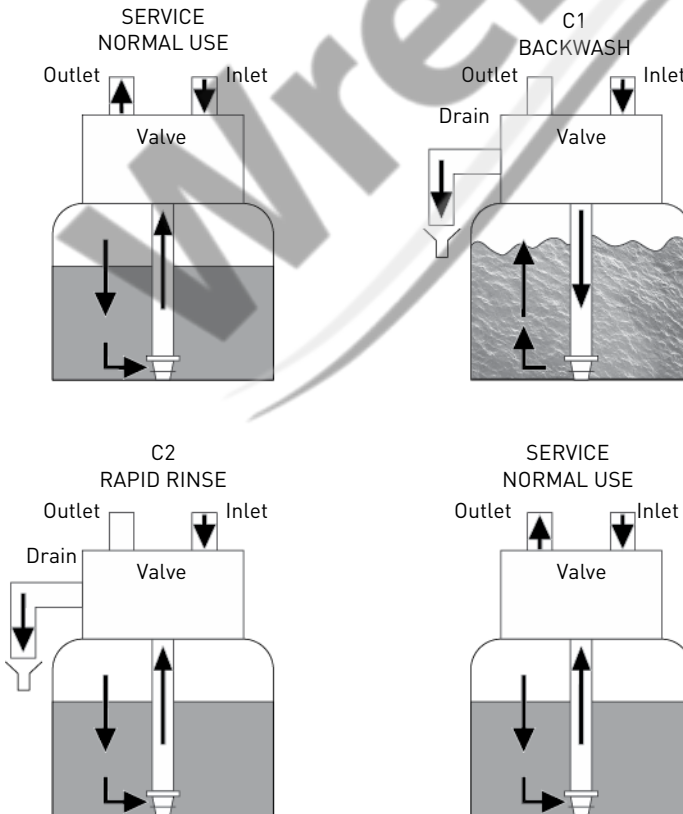

3.5. Configurations for downflow softener, upflow softener and filter

3.5.1. Downflow softener

The injector is in the upper hole and the plug in the lower hole.

3.5.2. Upflow softener

The injector is in the lower hole and the plug in the upper hole.



Note

For upflow configuration, the injector cap is fitted with a pressure regulator.

3.5.3. Filter

A plug is placed in both holes and in the brine line inlet.

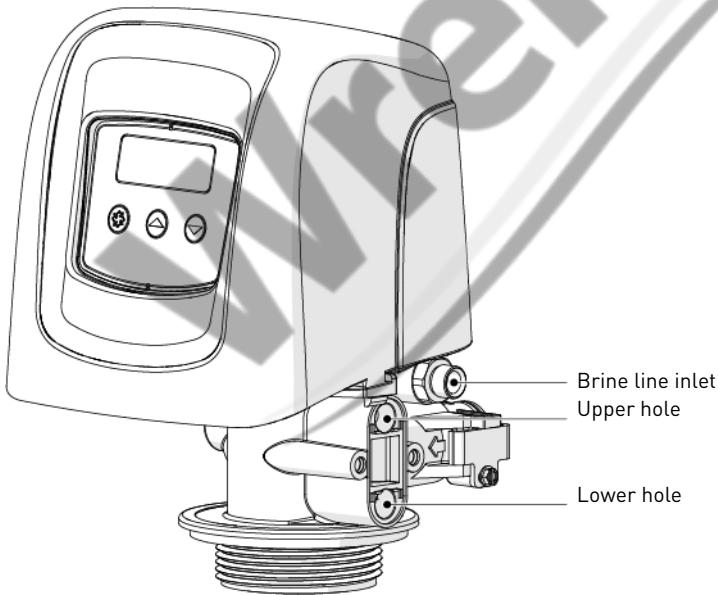

3.6. Options available on the valve

Mixing device

The valve can be equipped with a mixing device (1) whose function is to regulate the hardness of the water at the outlet. The mixing can be set from 0% to 50% of hard water (i.e. 0 turn = 0% of hard water with 100% of treated water and 1-½ turn = 50% of hard water with 50% of treated water).

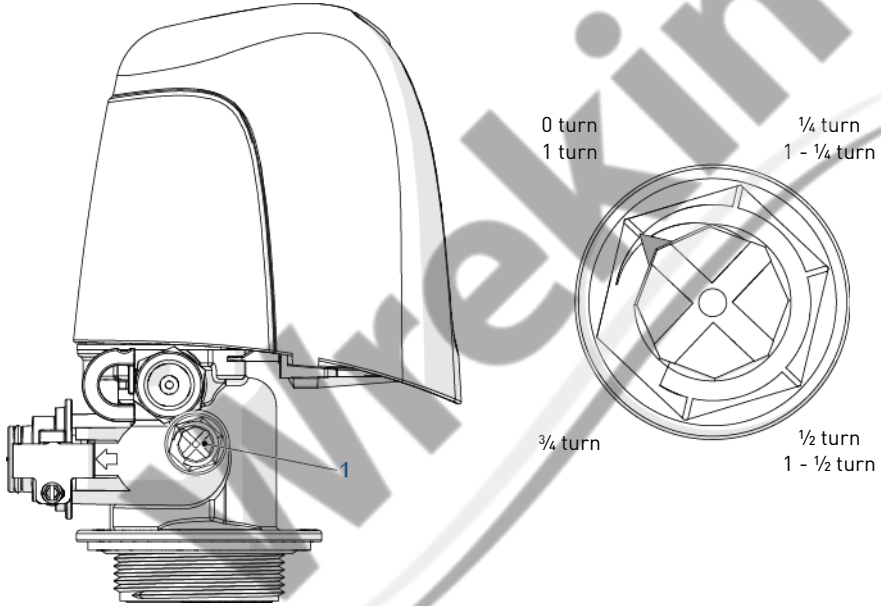

4. System sizing

4.1. Recommendations

4.1.1. Injector/DLFC/BLFC-Valve configuration

Valve type	Tank diameter	Resin volume	Injector				DLFC	BLFC	
	[in]	L	DF	Color	UF	Color	[gpm]	DF [gpm]	UF [gpm]
5800/ 1650	4	4	0	Red	0000	Black	0.8	0.125	0.125
	6	5 - 7			000	Brown	1.2		
	7	8 - 14							
	8	9 - 21	1	White	00	Violet	1.5	0.25	0.25
	9	22 - 28			0	Red	2		
	10	29 - 42					2.4		
	12	43 - 56	2	Blue	1	White	3.5	0.50	0.25
	13	57 - 70					4		
	14	71 - 85	3	Yellow	2	Blue	5		
	16	86 - 113					7		



Note

In upflow configuration, it is highly recommended to set the injector cap with a pressure regulator set to 1.4 or 2 bar.

4.2. Sizing a softener (single unit)

4.2.1. Parameters to be considered

Whenever installing a softener, it is preferable to have full water analysis to ensure the inlet water content will not affect the resin bed.



Note

Please consult your resin manufacturer specifications to ensure that no additional pretreatment prior to softening is required.

The below sizing method can be applied for both residential and industrial softeners.

The sizing of a softener must be based upon certain parameters:

- Inlet water hardness;
- Peak flow rate and nominal flow rate;
- Service velocity;
- Salt dosage.

The softening and regeneration reactions are driven under certain conditions. To allow these reactions to take place, make sure that the velocity is convenient during the different phases for proper ion exchange. This velocity is given in the resin manufacturer specifications sheet.

Depending on the inlet water hardness, the service velocity for standard softening must be between:

Service velocity [bed volume per hour]	Inlet water hardness [mg/l as CaCO ₃]	°f °TH	°dH
8 - 40	< 350	<35	<19.6
8 - 30	350 to 450	35 - 45	19.6 - 25.2
8 -20	> 450	>45	>25.2



Note

Failure to respect the service velocity will lead to hardness leakage or even total softener inefficiency.

Note that the water supply piping size may also be useful when estimating the nominal flow rate, since the size of the piping allows a maximum flow rate to pass. Assuming the maximum velocity of water in pipes is about 3 m/s, a good estimation for most common pressure [3 bar] and temperature [16°C] is:

Piping size (external diameter)		Max. flow rate
[in]	[mm]	[m ³ /h at 3 m/s]
0.5	12	1.22
0.75	20	3.39
1	25	5.73
1.25	32	8.69
1.5	40	13.57
2.0	50	21.20
2.5	63	34.2
3.0	75	49.2

4.2.2. Determining the required volume of resin

When sizing a softener, make sure that the volume of resin in the tank (bed volume) will be sufficient so that even when the peak flow rate is reached, the velocity is still between the above values depending on the hardness. When sizing a softener, always choose the resin volume and tank size based on the peak flow rate but not on the nominal flow rate.



Note

Sizing on the nominal flow rate without taking the peak flow rate into account would result in choosing smaller tank size and resin volume, and may lead in severe hardness leakage during the service cycle when the peak flow is reached.

The maximum softened water flow rate that a softener can produce is given by the following formula:

$$Q_{\text{service max}} = F_{\text{service}} \times BV$$

with:
 $Q_{\text{service max}}$: service flow rate [m³/h]
 F_{service} : service velocity [BV/h]
 BV : bed volume of resin [m³]

Knowing this required volume of resin, it is possible now to determine the tank you need. Note that at least a third of the total volume of the tank must be kept as free space so that the bed expansion during backwash is sufficient to ensure correct cleaning of the resin.

4.2.3. Resin exchange capacity and capacity of the unit

The resin exchange capacity and capacity of the unit are two different things that should not be confused. The resin exchange capacity is the amount of Ca²⁺ and Mg²⁺ that can be retained by 1 litre of resin, which will depend on the resin type and salt dosage, whereas the capacity of the unit is the capacity of the system, which will depend on the volume of resin and resin exchange capacity.

Knowing the required volume of resin and the tank size, you can determine the exchange capacity of the unit. The capacity of the unit can be expressed in different ways:

- The mass capacity, which corresponds to the weight in equivalent CaCO₃ that can be fixed on the resin, expressed in kg as CaCO₃;
- The volume capacity, which represents the maximum amount of water that can be treated between 2 regenerations. This last capacity takes into account the hardness of the water to be treated and is expressed in m³ or litres;
- The combined capacity, which represents the volume of water that could be treated between 2 regenerations if the inlet hardness is 1 °f or °dH. This capacity is expressed in °f.m³ or °dH.m³.

The unit exchange capacity will depend on the amount of salt to be injected into the resin bed during the regeneration. This amount of salt is given in grams per litre of resin. The 2 next tables are showing the resin exchange capacity in function of the amount of salt for a system with standard efficiency regeneration and for a system with high efficiency regeneration.

Resin exchange capacity as a function of the salt dosage:

Salt amount [g/L _{resin}]	Corresponding resin exchange capacity in [g/L _{resin}] as CaCO ₃	°f.m ³ [per L _{resin}]	°dH.m ³ [per L _{resin}]
50	29.9	2.99	1.67
60	34	3.4	1.9
70	37.5	3.75	2.09
80	40.6	4.06	2.27
90	43.4	4.34	2.42
100	45.9	4.59	2.56
110	48.2	4.82	2.69
120	50.2	5.02	2.8
130	52.1	5.21	2.91
140	53.8	5.38	3.01
150	55.5	5.55	3.1
170	58.5	5.85	3.27
200	62.7	6.27	3.5
230	66.9	6.69	3.74
260	71	7.1	3.97
290	75.3	7.53	4.21

To calculate the system mass capacity:

$$M_{\text{capacity}} = V_{\text{resin}} \times C_{\text{resin ex}}$$

with:

M_{capacity} : system mass capacity [g as CaCO₃]
 V_{resin} : volume of resin [L]
 $C_{\text{resin ex}}$: resin exchange capacity [g/L_{resin} as CaCO₃]

To calculate the system combined capacity:

$$C_{\text{capacity}} = V_{\text{resin}} \times C_{\text{cor resin ex}}$$

with:

C_{capacity} : system combined capacity [°f.m³ or °dH.m³]
 V_{resin} : volume of resin [L]
 $C_{\text{cor resin ex}}$: corresponding resin exchange capacity [°f.m³/l or °dH.m³/l]

To calculate the system volume capacity:

$$V_{\text{capacity}} = M_{\text{capacity}} / TH_{\text{inlet}}$$

or

$$V_{\text{capacity}} = C_{\text{capacity}} / TH_{\text{inlet}}$$

with:
 V_{capacity} : system volume capacity [m³]
 M_{capacity} : system mass capacity [kg as CaCO₃] or [°f.m³ or °dH.m³]
 C_{capacity} : system combined capacity [°f.m³ or °dH.m³]
 TH_{inlet} : inlet water hardness [mg/L as CaCO₃] or [°f or °dH]



Caution

If M_{capacity} must be expressed in [kg] the value must be divided by 1000.



Caution

If a mixing device is set on the valve, the inlet water hardness will need to be adjusted to the actual outlet residual hardness setup.

Having determined the previous capacity allows the operator to know the service cycle duration.

4.2.4. Valve configuration

Knowing the volume of resin, tank size and specifications of the resin, it is possible to determine the required valve configuration. The resin specification will give the backwash velocity, as well as the brine draw and slow rinse velocity that must be respected in order to ensure a proper regeneration of the unit. From this data, determine the required backwash flow rate as well as the brine draw and service flow rate. In most cases, the fast rinse flow rate will be the same as the backwash flow rate, however for certain valve types the fast rinse flow rate will be the same as the service flow rate.

To determine the backwash flow rate:

$$Q_{\text{backwash}} = F_{\text{backwash}} \times S$$

with:
 Q_{backwash} : backwash flow rate [m³/h]
 F_{backwash} : backwash velocity [m/h]
 S : Tank cross section area [m²]

The DLFC installed on the valve has to limit the backwash flow rate to the above calculated flow rate.

To determine the injector size:

The velocities to be respected for brine draw and slow rinse are given on the resin manufacturer specifications. Generally speaking, the injector has to allow a flow rate of about 4BV/h (corresponding to the flow rate of brine being drawn added to the flow rate of raw water passing through the injector nozzle to create the suction effect).

$$Q_{inj} = 4 \times BV / h$$

with:
 Q_{inj} : total flow rate passing through the injector [L/h]
 BV : bed volume of resin [L]



Note

This value does not correspond to the brine draw flow rate but to the total flow rate passing through the injector. Then refer to the injector diagrams for the chosen tank size and at the inlet pressure in order to check if the injector will give a correct flow rate. See "1650 Injector flow rates", page 33.

4.2.5. Cycle time calculation

From this point, the volume of resin, the tank size and the capacity of the softener are determined. Next step is to calculate the regeneration cycle duration, which depend on the valve configuration and once again on the resin specifications.



Note

Preprogrammed cycle times are only factory default programming that need to be adjusted to fit the system requirements).

For cycle time calculation the valve configuration must be known, which depends on:

- the tank size;
- the resin volume previously determined;
- the salt amount used per regeneration;
- the resin specifications for the velocity and volume of water to use for backwashing the resin bed;
- the velocity and volume of water for brine draw and slow rinse;
- the velocity and volume of water to use for fast rinse.

To calculate the backwash duration:

$$T_{backwash} = (N_{Bbw} \times BV) / Q_{DLFC}$$

with:
 $T_{backwash}$: backwash duration [min]
 N_{Bbw} : number of bed volume needed for backwash
 BV: bed volume [L]
 Q_{DLFC} : drain line flow controller size [L/min]



Note

The typical value of the volume of water to be used for backwash is between 1.5 and 4 times the bed volume, depending on the inlet water quality.

To calculate the brine draw duration:

Knowing the injector flow rate at the working pressure:

$$T_{\text{brine draw}} = V_{\text{brine}} / Q_{\text{inj}}$$

with:
 $T_{\text{brine draw}}$: brine draw duration [min]
 V_{brine} : brine volume to be drawn [L] see Refill calculation page 32
 Q_{inj} : injection draw flow rate [L/min]

Note

Multiply the amount of salt in kg by 3 to get a approximation of the brine volume to draw.

To calculate slow rinse duration:

The volume of water to be used for slow rinse is given in the resin manufacturers specifications. Generally speaking, it is advised that between 2 and 4 BV of water is used to perform the slow rinse after brine draw. The slow rinse cycle allows brine to be pushed slowly through the resin bed, allowing the resin to be in contact with brine for sufficient time and therefore to be regenerated.

Refer to the injector curve at the common working pressure to determine the slow rinse duration.

$$T_{\text{slow_rinse}} = (N_{\text{BV}} \times \text{BV}) / Q_{\text{SR}}$$

with:
 $T_{\text{slow_rinse}}$: slow rinse duration [min]
 N_{BV} : number of BV
 BV: bed volume [L]
 Q_{SR} : injector slow rinse flow rate [L/min]

To calculate fast rinse duration:

The fast rinse is aimed at eliminating an excess of salt in the resin bed and also recompacting the resin in the tank.

Depending on the valve type, the fast rinse flow rate is controlled by the DLFC or it has about the same flow rate as in service. The fast rinse velocity can be the same as the service velocity, and the volume of water to be used for the fast rinse is generally between 1 and 10 BV depending on the salt dosage.

$$T_{\text{fast_rinse}} = (N_{\text{BVfr}} \times \text{BV}) / Q_{\text{DLFC}}$$

with:
 $T_{\text{fast_rinse}}$: fast rinse duration [min]
 N_{BVfr} : number of BV for fast rinse
 BV: bed volume [L]
 Q_{DLFC} : drain line flow controller size [L/min]

To calculate the refill duration:

The refill flow rate is controlled by the refill controller (BLFC). The relation between the BLFC size, the tank size and the resin volume is given in the valve specifications.

To calculate the refill duration:

$$T_{\text{refill}} = V_{\text{WB}} / Q_{\text{BLFC}}$$

with:
 T_{refill} : refill duration [min]
 V_{WB} : Volume of water to be refill to prepare the brine [L]
 Q_{BLFC} : BLFC flow rate [L/min]

$$V_{\text{WB}} = D_{\text{Salt}} \times BV / S_{\text{sol}}$$

with:
 V_{WB} : Volume of water to be refill to prepare the brine [L]
 D_{Salt} : Salt dosage per litre of resin [gr/L]
 BV : Bed volume [L]
 S_{sol} : 360gr/L - Solubility of salt per litre of water



Note

When calculating the time required to draw the brine, take into account that the volume of brine [V_{brine}] will be 1.125 bigger than the water refilled.

4.3. Salt amount definition

The salt settings is done through the controller programming.

4.4. 1650 Injector flow rates

The following tables and graphics represent the injectors flow rate as a function of the inlet pressure for the different injector sizes.

INJECTOR 000

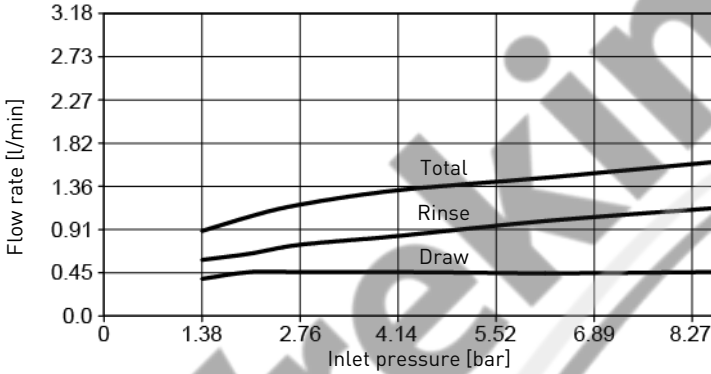

INJECTOR 00

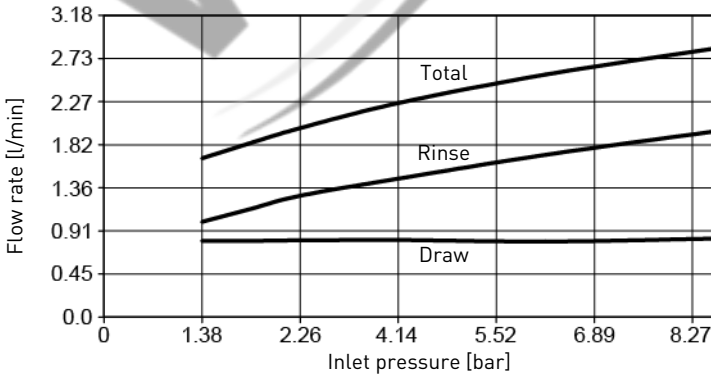

INJECTOR 0

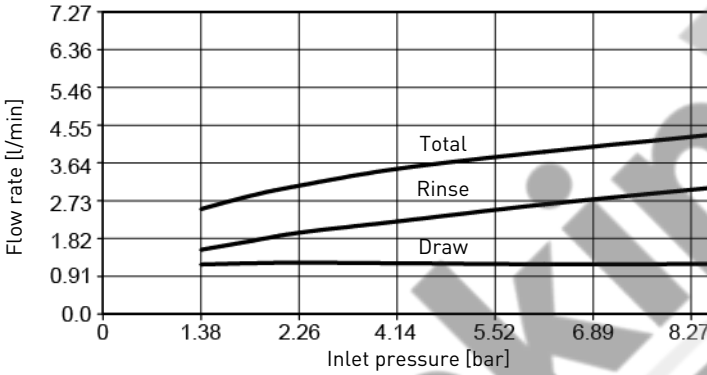

INJECTOR 1

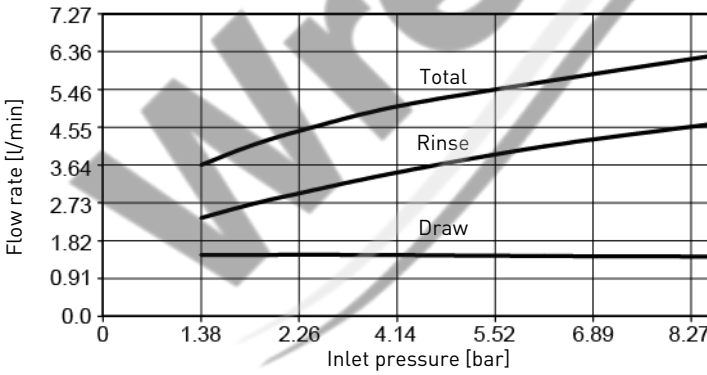

INJECTOR 2

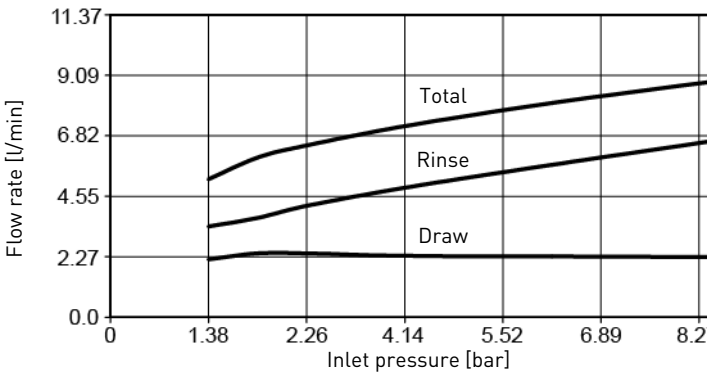

INJECTOR 3

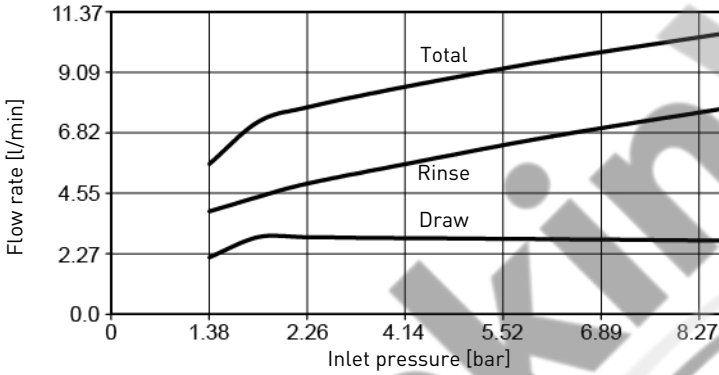

INJECTOR 4

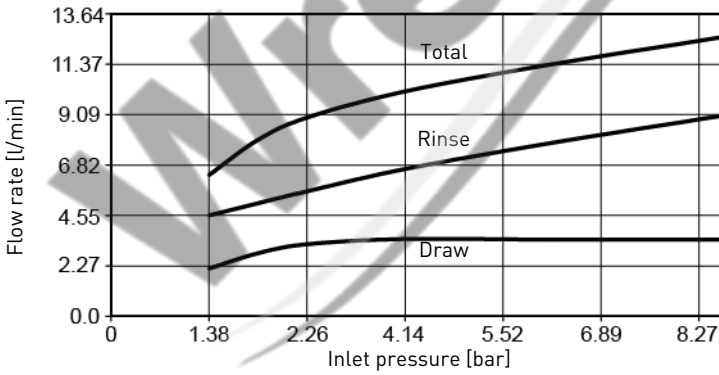

INJECTOR 5

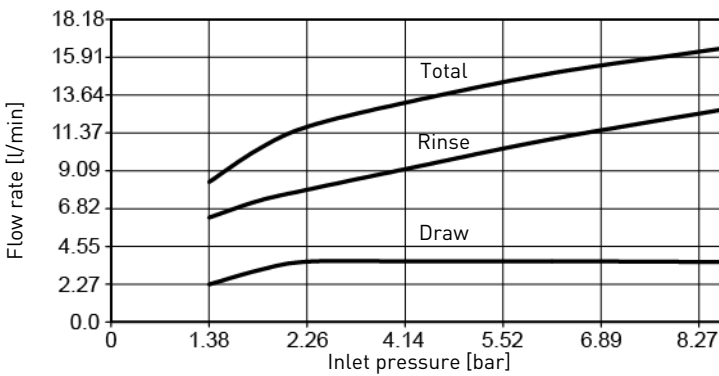

5. Installation



Mandatory

It is strictly forbidden for not qualified personal, to accede to system's internal parts to perform any kind of technical action. Be sure to disconnect the electrical power, close the water inlet and depressurize the system before opening the front cover to access internal parts.

5.1. Warnings

The manufacturer will not be held liable for any damages to people or properties resulting from an improper use of the device not compliant with the following instructions.

Whenever this guide doesn't clarify all doubts about installation, service or maintenance, please contact the technical support of the company that has installed the device.

Device installation must be done by a qualified technician according to the current standards and regulations, using tools compliant with the device for a safe use and referring to that technician also for device maintenance.

In case of out of order or malfunction, before performing any kind of action on the device, please ensure to have disconnected the transformer from the power source, to shut off inlet water supply to the valve and to drain water pressure opening a tap down-line of the valve.

1. Be careful when removing the valve from the box and during subsequent handling, weight is liable to cause damage to property and persons in case of accidental impact.
2. Before sending the water on the valve, make sure that all plumbing connections are tight and properly implemented in order to avoid dangerous leaks of pressurized water.
3. Use caution when installing welded metal piping near the valve, the heat may damage the plastic body of the valve and the bypass.
4. Be careful not to let the full weight of the valve rest on fittings, pipes or bypass and vice versa.
5. Make sure that the environment in which the valve is installed does not reach water freezing temperatures, the valve may be damaged.
6. Make sure that the tank containing the resin is vertical, otherwise the resin could enter in the valve and damage it.

5.2. Safety notices for installation

- Observe all warnings that appear in this manual.
- Only qualified and professional personnel are authorized to carry out installation work.

5.3. Installation environment

5.3.1. General

- Use only brine salts designed for water softening. Do not use ice melt salt, block, or rock salts.
- Keep the media tank in the upright position. Do not turn on its side, upside down, or drop. Turning the tank upside down may cause media to enter the valve or plug the upper screen.
- Follow State and local codes for water testing. Do not use water that is micro-biologically unsafe or of unknown quality.
- When installing the water connection (bypass or manifold) first connect to the plumbing system. Allow heated parts to cool and cemented parts to set before installing any plastic parts. Do not get primer or solvent on O-rings, nuts, or the valve.

5.3.2. Water

- Water temperature must not exceed 43°C.
- A minimum of 1.4 bar (dynamic pressure on injector) of water pressure is required for the regeneration valve to operate effectively.



Mandatory

Do not exceed a maximum of 8.6 bar inlet pressure. Should this happen or be subject to happen, it is necessary to install a pressure regulator upstream the system.

5.3.3. Electrical

There are no user-serviceable parts in the AC/DC adapter, motor, or controller. In the event of a failure, these should be replaced.

- All electrical connections must be completed according to local codes.
- Use only the power AC/DC adapter that is supplied.



Mandatory

The use of any other power adapter than the one supplied void the warranty of all electronic parts of the valve.

- The power outlet must be grounded.
- To disconnect power, unplug the AC/DC adapter from its power source.
- An uninterrupted current supply is required. Please make sure that the voltage supply is compatible with the unit before installation.
- Make sure the controller power source is plugged in.
- If the electrical cable is damaged, it must imperatively be replaced by qualified personnel.

5.3.4. Mechanical

- Do not use petroleum-based lubricants such as vaseline, oils, or hydrocarbon-based lubricants. Use only 100% silicone lubricants.
- All plastic connections should be hand tightened. PTFE (plumber's tape) may be used on connections that do not use an O-ring seal. Do not use pliers or pipe wrenches.
- Existing plumbing should be in a good shape and free from limescale. In case of doubt, it is preferable to replace it.
- All plumbing must be completed according to local codes and installed without tension or bending stresses.
- Soldering near the drain line should be done before connecting the drain line to the valve. Excessive heat will cause interior damage to the valve.
- Do not use lead-based solder for sweat solder connections.
- The riser tube should be cut 5.7 mm below the top of the tank. Slightly bevel the ridge in order to avoid deterioration of the seal whilst fitting the valve.
- The drain line must be a minimum of 12.7 mm (1/2") in diameter. Use 19 mm (3/4") pipe if the backwash flow rate is greater than 26.5 lpm (7 gpm) or the pipe length is greater than 6 m (19 ft 8 in).
- Do not support the weight of the system on the valve fittings, plumbing, or the bypass.

- It is not recommended to use sealants on the threads. Use PTFE (plumber's tape) on the threads of the drain elbow, and other NPT/BSP threads.
- The installation of a prefilter is always recommended (100µ nominal).
- Valve inlet/outlet must be connected to main piping via flexible.

5.4. Integration constraints

Location of a water treatment system is important. The following conditions are required:

- Flat and firm level platform or floor;
- Room to access equipment for maintenance and adding brine (salt) to tank;
- Constant electrical supply to operate the controller;
- Total minimum pipe run to water heater of 3 m to prevent backup of hot water into system;
- Always install check valve before water heater to protect the softener from hot water return;
- Local drain for discharge as close as possible;
- Water line connections with shut off or bypass valves;
- Must meet any local and state codes for site of installation;
- Valve is designed for minor plumbing misalignments. Do not support weight of system on the plumbing;
- Be sure all soldered pipes are fully cooled before attaching plastic valve to the plumbing.

5.5. Valve connection to piping

The connections should be using PTFE (plumber's tape) on the threads if using the threaded connection type.

In case of heat welding (metal type connection), the connections should not be made to the valve when soldering.

**Note**

See chapter 3.3. Description and components location, page 15 to identify the connections.

5.5.1. Top-mounted valve installation

When pressurized, any composite tank will expand both vertically and circumferential. In order to compensate the vertical expansion, the piping connections to the valve must be flexible enough to avoid overstress on the valve and tank.

In addition, the valve and tank should not be supporting any part of the piping weight. This is hence compulsory to have the piping fixed to a rigid structure (e.g. frame, skid, wall...) so that the weight of it is not applying any stress on the valve and tank.

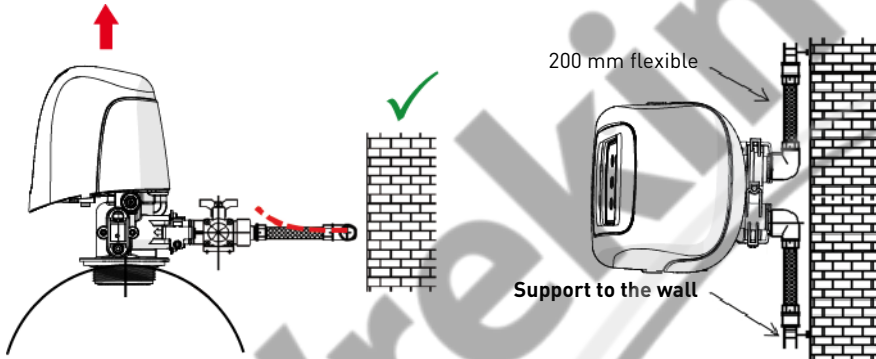

- The diagrams above illustrate how the flexible piping connection should be mounted.
- In order to adequately compensate the tank elongation the flexible piping must be installed **horizontally**.
- Should the flexible piping connection be installed in vertical position, instead of compensating the elongation, it will create additional stresses on the valve & tank assembly. Therefore this is to be avoided.
- The flexible piping connection must also be installed stretched, avoiding excessive length. For instance 20 - 40 cm is enough.
- Excessively long and non-stretched flexible piping connection will create stresses on the valve and tank assembly when the system is pressurized, as illustrated in the below picture: on the left the assembly when the system is unpressurised, on the right the flexible piping connection when put under pressure tends to lift up the valve when stretching up. This configuration is even more dramatic when using semi-flexible piping.
- Failure to provide enough vertical compensation may lead to different kinds of damage, either on the valve thread which connects to the tank, or on the female thread connection of the tank that connects to the valve. In some cases, damage may also be seen on the valve inlet and outlet connections.

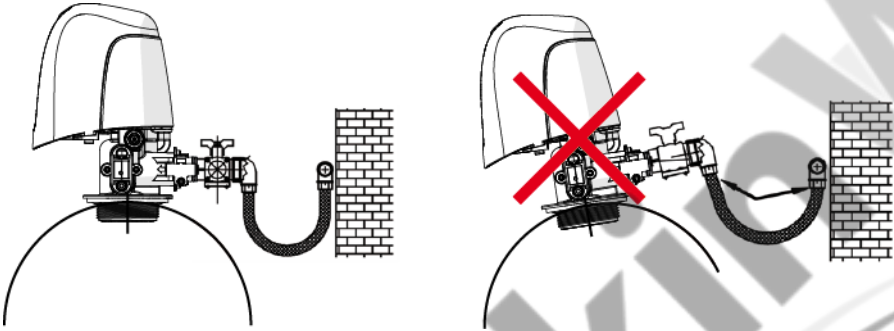

- In any case, any failure caused by improper installation and/or piping connections may void the warranty of Pentair products.
- In the same way, using lubricant* on the valve thread is not allowed and will void the warranty for the valve and tank. Indeed using lubricant there will cause the valve to be over-torqued, which may lead to valve thread or tank thread damage even if the connection to piping has been done following the above procedure.

*Note: Use of petroleum-based grease and mineral based lubricant is totally forbidden, not only on the valve thread, since plastics used (especially Noryl) will highly suffer from contact with this type of grease, leading into structural damage hence to potential failures.

5.6. Block diagram and configuration example

Configuration example

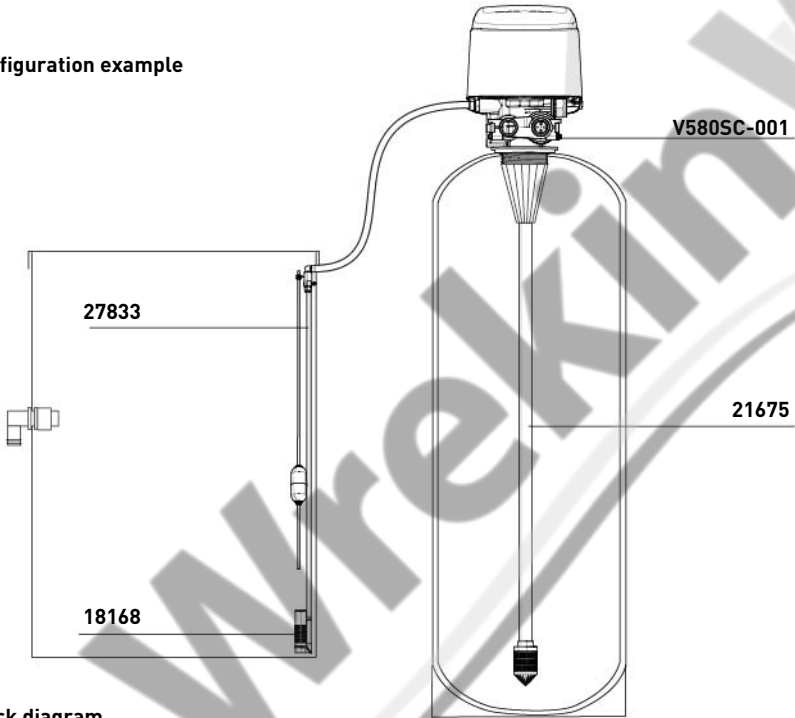

Block diagram

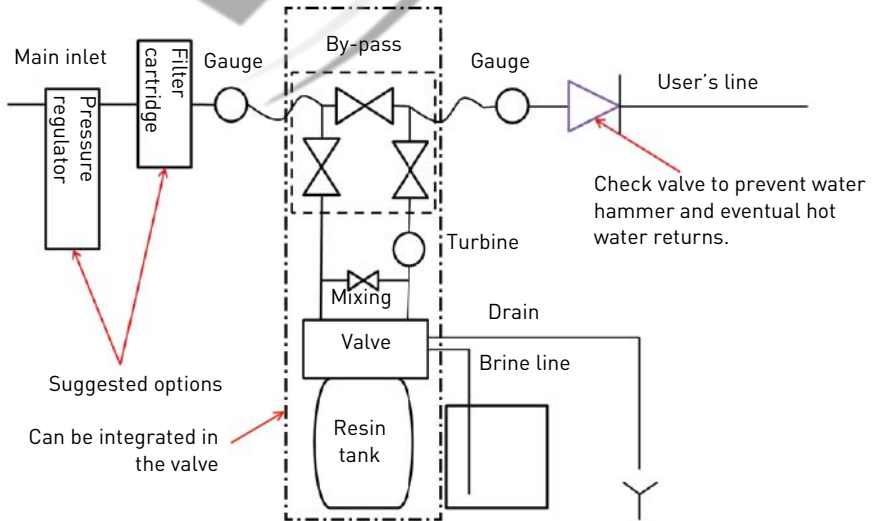

5.7. Regeneration types

Metered:

The controller monitors the volume of water used. Once it calculates that there is not enough capacity for the next days operation, a regeneration cycle will be initiated immediately or at a pre-set time.

- **Immediate control:** The controller measures water usage and regenerates the system as soon as the system capacity is reached.
- **Delayed control:** The controller measures water usage and regenerates the system, at the specified regeneration time, after the system capacity is reached.

Time clock:

The controller will regenerate based on a set number of operation days.

- **Delayed control:** The controller will regenerate the system, at the specified regeneration time, when the number of days since the last regeneration equals the regeneration day override value.
- **Day of the week control:** The controller will regenerate the system, at the specified regeneration time, on each programmed days of the week.

5.8. Electrical connections

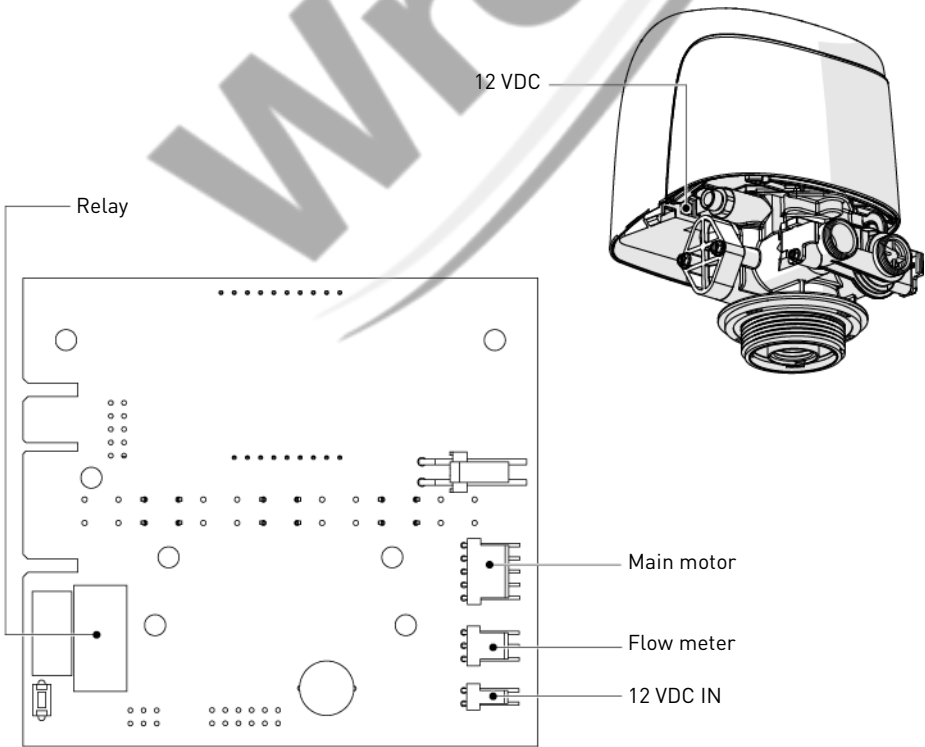

5.9. By-passing

A bypass valve system should be installed on all water conditioning systems. Bypass valves isolate the softener from the water system and allow unconditioned water to be used. Service or routine maintenance procedures may also require that the system is bypassed.

Normal operation

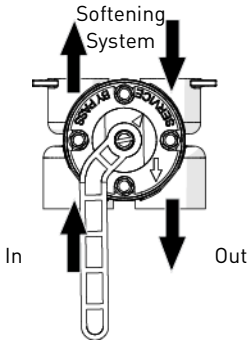

In Bypass

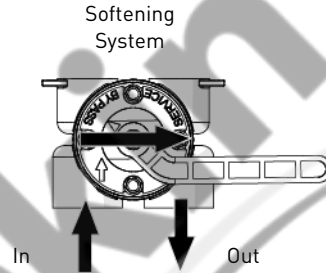

Caution

Do not solder pipes with lead-based solder.



Caution

Do not use tools to tighten plastic fittings. Over time, stress may break the connections.



Caution

Do not use petroleum grease on gaskets when connecting bypass plumbing. Use only 100% silicone grease products when installing any plastic valve. Non-silicone grease may cause plastic components to fail over time.

5.10. Drain line connection



Note

Standard commercial practices are expressed here. Local codes may require changes to the following suggestions. Check with local authorities before installing a system.

Preferably, the unit should not be more than 6.1 m from the drain. Use an appropriate adapter fitting to connect plastic tubing to the drain line connection of the valve.

If the backwash flow rate exceeds 58 lpm or if the unit is located 6.1-12.2 m from the drain, use 25.4 mm (1") tubing. Use appropriate fittings to connect the 25.4 mm (1") tubing to the 19.0 mm (¾") drain connection on the valve.

The drain line may be elevated up to 1.8 m providing the run does not exceed 4.6 m and water pressure at the softener is not less than 2.76 bar. Elevation can increase by 61 cm for each additional 0.69 bar of water pressure at the drain connector.

Where the drain line is elevated but empties into a drain below the level of the valve, form a 18 cm loop at the far end of the line so that the bottom of the loop is level with the drain line connection. This will provide an adequate siphon trap.

Where the drain empties into an overhead sewer line, a sink-type trap must be used. Secure the end of the drain line to prevent it from moving.



Note

Waste connections or the drain outlet shall be designed and constructed to provide connection to the sanitary waste system through an air-gap of 2 pipe diameters or 50.8 mm (2"), whichever is larger.



Caution

Never insert the drain line directly into a drain, sewer line or trap. Always allow an air gap between the drain line and the wastewater to prevent the possibility of sewage being back-siphoned into the softener.

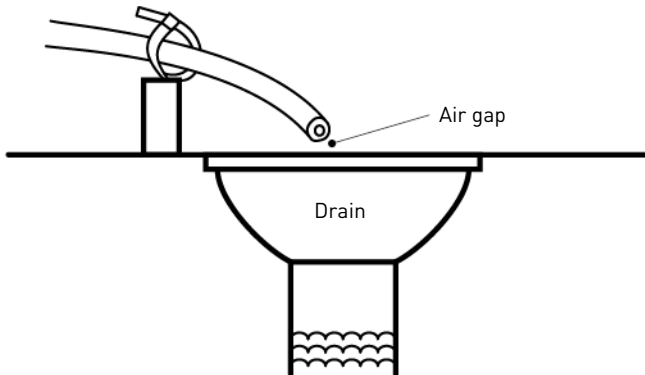

5.11. Overflow line connection

In the event of a malfunction, power failure, etc, the brine tank overflow fitting will direct “overflow” to the drain instead of spilling on the floor. This fitting should be on the side of the cabinet or brine tank. Most tank manufacturers include a post for the tank overflow connector.

To connect the overflow line, locate the hole on side of tank. Insert overflow fitting into tank and tighten with plastic thumb nut and gasket as shown below. Attach a length of 12.7 mm (½”) I.D. tubing (not supplied) to fitting and run to drain.

Do not elevate overflow higher than overflow fitting.

Do not tie into drain line of controller unit. Overflow line must be a direct, separate line from overflow fitting to drain, sewer or tub. Allow an air gap as per drain line instructions.

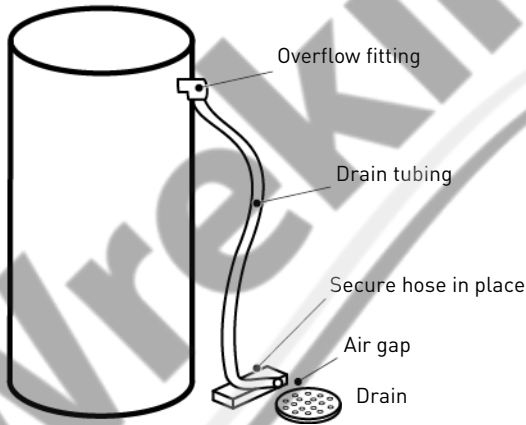

Caution

Floor drain is always recommended to avoid flooding in case of overflow.

5.12. Brine line connection

The brine line from the tank connects to the valve. Make the connections and hand tighten. Be sure that the brine line is secure and free from air leaks. Even a small leak may cause the brine line to drain out, and the softener will not draw brine from the tank. This may also introduce air into the valve, causing problems with the valve operation.

Most installations utilize a tank check valve.

6. Programming

6.1. Display

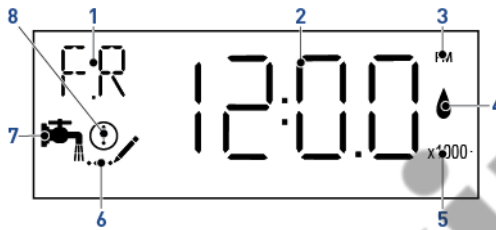

1. Parameter display



- C: Unit capacity;
- CD: Current day;
- Cn, n=1 to 20: Cycle number;
- CR: Variable reserve capacity;
- CT: Regeneration control type;
- DF: Display format;
- Dn, n=1 to 7: Day of week;
- DO: Days override;
- ET: Relay end time;
- FM: Flow meter;
- FR: Current flow rate;
- H: Feedwater hardness;
- HR: Hours in service;
- K: Meter pulse;
- PF: Peak flow rate;
- RC: Fixed reserve capacity;
- RE: Relay setting;
- RF: Regeneration flow;
- RS: Reserve selection;
- RT: Regeneration time;
- SF: Safety factor;
- ST: Relay start time;
- SV: Software version;
- TD: Time of day;
- T0: Relay time on;
- TV: Totalizer;
- V: Filter capacity;
- V0: Volume interval;
- VU: Volume used;
- VT: Valve type.

Regeneration cycles:

- B1: First backwash (for dF2b regeneration mode);
- B2: Second backwash (for dF2b regeneration mode);
- BD: Brine draw;
- BF: Brine fill;
- BW: Backwash;
- RF: Refill;
- RR: Rapid rinse;
- SP: Service position;
- SR: Slow rinse.





- 2. Data display
- 3. PM indicator → Appears if controller set in US unit.
- 4. Flow indicator → Flashes when outlet flow is detected.
- 5. x1000 indicator → Appears when the displayed number is bigger than 9999.
- 6. Programming icon → Appears in programming modes.
- 7. Service icon → Appears in service mode;
→ Flashes if a regeneration cycle has been queued.
- 8. Error / Information icon → Appears in case of error, see page 75, or in diagnostic mode, see page 61.

6.2. Commands

- A Press  to pass to the next step.
- B Use  and  to adjust the values.

6.3. Setting the time of the day (TD)

Set the time in the system.

- A Press and hold  or  until the programming icon replaces the service icon and the parameter display reads TD.
- B Set the time with  or .
- C Press  to validate the selection and return to the service mode, or wait for 10 seconds.

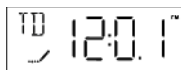

6.4. Basic programming







Note

Menus are displayed in a defined and incremental order.

6.4.1. Day of Override (DO)

Determine the maximum number of days of operation without regeneration.

- A Press  and  simultaneously for 5 seconds to enter the menu sequence.
- B Select the number of days of Override with  and .
- C Press  to validate the selection and advance to the next parameter.



6.4.2. Regeneration time (RT)

Determine the time of regeneration.

D Adjust the regeneration time with ▼ and ▲.

E Press  to validate the selection and advance to the next parameter.



6.4.3. Feed Water Hardness (H)

Determine the feed water hardness in °tH.

F Adjust the water hardness with ▼ and ▲.

G Press  to validate the selection and advance to the next parameter.



6.4.4. Reserve capacity (RC) or (SF)

Determine the reserve capacity in litre or in percentage.

H Adjust the reserve capacity with ▼ and ▲.

I Press  to validate the selection and advance to the next parameter.



6.4.5. Current day of the week (CD)

Determine the day of regeneration.



Note

Appears only if the softener is set to "weekly time clock".



Note

1 for Monday, 2 for Tuesday, 3 for Wednesday, 4 for Thursday, 5 for Friday, 6 for Saturday and 7 for Sunday.

J Adjust the day of the week with ▼ and ▲.

K Press  to validate the selection and exit the basic programming mode.



6.5. Master programming mode



Note

As soon as programming mode is entered, all parameters can be displayed or set to suit the needs. Depending on the current programming, some functions will not be displayed or will not be changeable.



Note

If no button is pressed for 5 minutes in the Programming mode (basic or master mode), or if there is a power failure, the controller returns to Service mode and changes made are not saved.



Note

Menus are displayed in a defined and incremental order.



Mandatory

In order to save the new settings in the programming mode, it is necessary to go through all the parameters.

6.5.1. Master programming mode chart

Parameter		Options	Definition	Note
DF	Display format	GAL	US units	
		Ltr	Metric units	
VT	Valve type	5800	-	
		5810	-	
		5812	-	
RF	Regeneration flow	dF1b	Std DF single backwash	
		dF2b	Std DF double backwash	
		dFFF	DF fill first	
		UFFF	UF fill first	
		UFbd	UF brine first	
		FLtr	Filter	To be used with standard piston only.
		UFIt	UF filter	To be used with UF piston only.
		O-dF	Other DF	
		O-UF	Other UF	

Parameter		Options	Definition	Note
CT	Regeneration control type	Fd	Meter delayed	
		FI	Meter immediate	
		tc	Time clock	
		dAY	Day of the week	
C	Unit capacity	0.1 to 9'999'000	°TH*m ³	Only displayed for volumetric regenerations.
V	Filter capacity	1 to 999'900	L	Only displayed for filter.
H	Feedwater hardness	1 to 1990	°TH, ppm or grains	Only displayed for volumetric regenerations.
RS	Reserve selection	SF	Safety factor	
		rc	Fixed reserve capacity	
		cr	Variable reserve capacity	
SF	Safety factor	0 to 50	%	Only available if set in reserve selection.
RC	Fixed reserve capacity	0 to 50	%	Only displayed for volumetric regenerations and if set in reserve selection.
CR	Variable reserve capacity			
DO	Days override	0 to 99	Day	
RT	Regeneration time	00:00:00 to 23:59:59	Hour	Regeneration time will not appear unless regeneration day override is on.
B1	First backwash	0 to 199	Minute	Only displayed for dF2b regeneration flow.
B2	Second backwash			
BD	Brine draw			
BF	Brine fill			
BW	Backwash			
RF	Refill			
RR	Rapid rinse			
SP	Service position			
SR	Slow rinse			

Parameter		Options	Definition	Note
Cn	Cycle number, n=1 to 20	BD, BW, RF, RR, SP, SR, LC	-	Only displayed for O-dF and O-UF.
Dn	Day of week, n=1 to 7	On - OFF	-	Regeneration setting for each day of the week. OFF by default.
CD	Current day	1 to 7	Day of the week	
FM	Flow meter type	P0.7	¾" paddle wheel	
		t0.7	¾" turbine	
		P1.0	1" paddle wheel	
		t1.0	1" turbine	
		P1.5	1½" paddle wheel	
		t1.5	1½" turbine	
		P2.0	2" paddle wheel	
	Gen	Generic or non-Fleck		
K	Meter pulse	0.1 to 999.9	Litre	Only displayed for generic flow meter type.
RE	Relay setting	tb	Time based	
		Fb	Flow based	
ST	Start time	0 to the total of time of all the cycles minus 1	Minute	Only displayed for tb.
ET	End time	start time to the total of time of all the cycles		
VO	Volume interval	1 to the total capacity	Litre	Only displayed for Fb.
TO	Time ON	1 to 7200	Minute	

6.5.2. Entering master programming mode

- A** Press and hold ▼ or ▲ until the programming icon replaces the service icon and the parameter display reads TD.
- B** Set the time to 12:01 PM with ▼ or ▲.
- C** Press  to validate the selection and return to the service mode, or wait for 10 seconds.
- D** Press and hold ▼ and ▲ until the programming icon replaces the service icon and the display format screen appears.



6.5.3. Display format mode (DF)

Select the unit of measure.

Options:

- GAL: U.S. Gallons and 12-Hour AM/PM;
- Ltr; litres and 24-Hour.

- E** Press ▼ or ▲ to select the unit.
- F** Press  to validate the selection and move to the next parameter.

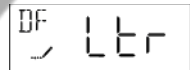

6.5.4. Valve type (VT)

Select the unit of measure.

Options: 5800, 5810 & 5812.

- G** Press ▼ or ▲ to select the valve type.
- H** Press  to validate the selection and move to the next parameter.

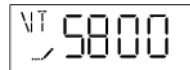



6.5.5. Regeneration flow (RF)

Select the regeneration flow.

Options:

- dF1b: Standard downflow single backwash;
- O-UF: Other upflow;
- O-dF: Other downflow;
- UFlt: Upflow filter, to be used with upflow piston only;
- UFFF: Upflow fill first;
- UFbd: Upflow brine first;
- dFFF: Downflow fill first;
- FLtr: Filter, to be used with standard piston only;
- dF2b: Standard downflow double backwash.

- I Press  or  to select the regeneration flow.
 J Press  to validate the selection and move to the next parameter.





6.5.6. Regeneration control type (CT)

Select the controller type.

Options:

- Fd: Meter delayed;
- Fl: Meter immediate;
- tc: Time clock;
- dAY: Day of the week.

- K Press  or  to select the controller type.
 L Press  to validate the selection and move to the next parameter.



6.5.7. Unit capacity (C)

Set the unit capacity.





Note

The unit capacity parameter is only available if the controller type has been programmed for volumetric regeneration.



Note

The unit capacity can be set from 0.1 to 9999 x 1000 °TH*m³, g as CaCO₃ equivalent.

- M Press  or  to select the unit capacity.
 N Press  to validate the selection and to move the next parameter.

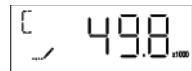

6.5.8. Filter capacity (V)

Set the unit capacity.





Note

The unit capacity parameter is only available if the controller type has been programmed for filter.



Note

The filter capacity can be set from 1 to 999.9 x 1000 L.

- O Press  or  to select the unit capacity.
 P Press  to validate the selection and to move the next parameter.

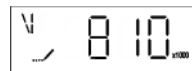

6.5.9. Feedwater hardness (H)

Set the feedwater hardness.



Note

The feedwater hardness parameter is only available if the controller type has been programmed for volumetric regeneration.





Mandatory

Enter the feedwater hardness in °TH, ppm or grains of hardness for softener system.



Note

The feedwater hardness can be set from 1 to 1990 °TH, ppm, or grains.

Q Press  or  to set the feedwater hardness in accordance with display format (DF), see chapter 6.5.3.

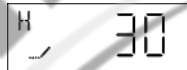

R Press  to validate the selection and to move the next parameter.

6.5.10. Reserve selection (RS)

Select the reserve.





Note

The reserve selection parameter is only available if the controller type has been programmed for volumetric regeneration.

Options:

- SF: Safety factor, in % of initial capacity;
- rc: Fixed reserve capacity (fixed volume in L);
- cr: Variable reserve capacity.

S Press  or  to select the type of reserve.

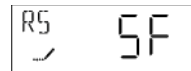

T Press  to validate the selection and move to the next parameter.

6.5.10.1 Safety factor (SF)

Set the safety factor.



Note

The safety factor parameter is only available if this option has been set in reserve selection.



Note

The safety factor can be set from 0 to 50% of the initial volumetric capacity.

U Press  or  to set the safety factor.

V Press  to validate the selection and move to the next parameter.



6.5.10.2 Fixed reserve capacity (RC)

Set the reserve capacity.



Note

The fixed reserve capacity parameter is only available if this option has been set in reserve selection.





Note

The fixed reserve capacity is a fixed volume and does not change if the unit capacity or feedwater hardness are changed.



Note

The fixed reserve capacity can be set up to a volume equivalent to 50% of the initial volumetric capacity.

W Press  or  to set the reserve capacity.

X Press  to validate the selection and move to the next parameter.



6.5.11. Days override (DO)

Set the maximum number of days between regeneration cycles.



Note

This parameter allows to set the maximum amount of days that the system can stay in service mode without a regeneration.



Mandatory

In time clock mode the setting of this parameter is mandatory and the electronic will need at least one regeneration day activated.





Note

Setting the parameter to "OFF" disables this function.



Note

The number of days can be set from OFF, or 1 to 99 days.

Y Press  or  to set the days override.

Z Press  to validate the selection and move to the next parameter.





6.5.12. Regeneration time (RT)

Set the regeneration time.



Note

Regeneration time is the time of the day when regenerations occur for delayed regeneration of any type and calendar override regeneration.

AA Press  or  to set the regeneration time.

AB Press  to validate the selection and move to the next parameter.



6.5.13. Regeneration cycle step duration

Set the duration in minutes of each regeneration cycle.



Note

Setting a cycle step to 0 will cause the controller to skip that step during regeneration, but keeps the following steps available.



Note

The different regeneration cycles are listed in sequence based on the regeneration flow selected for the system.



Note

All cycles can be set from 0 to 199 minutes.





Note

The abbreviations used are listed on chapter 6.5.13.1.

6.5.13.1 Regeneration abbreviations

B1	First backwash	RF	Refill
B2	Second backwash	RR	Rapid rinse
BD	Brine draw	SP	Service position
BF	Brine fill	SR	Slow rinse
BW	Backwash	SV	Service
LC	Last cycles		

6.5.13.2 For pre-set regeneration cycles

AC Press  or  to set the regeneration time.

AD Press  to validate the selection and move to the next parameter.



6.5.13.3 For regeneration type 0-UF and 0-DF





Note

The regeneration cycles are identified as C1 to C20.





Mandatory

The last cycle must be set with LC.

AE Press  or  to set the type of regeneration cycle.

AF Press  to validate the selection.

AG Press  or  to set the regeneration time of this cycle.

AH Press  to validate the selection and move to the next regeneration cycle.

AI Repeat **Z** to **AC** as needed.

AJ Select LC.

AK Press  to validate the selection and to move to the next parameter.



In this example:
C1 = Rapid Rinse
for 30 min

6.5.14. Day of week (Dn, n = 1 to 7)

Set the day of week for regeneration.



Note

The day of week parameter is only available if time clock week mode has been set in controller type selection.



Note

By default, every Dn is set to OFF.

AL Press  or  to set "ON" or "OFF" to set the day as a regeneration day.

AM Press  to validate the selection.

AN Repeat **AE** to **AF** until D7 is set.

AO Press  to validate the selection and move to the next parameter.

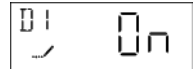

6.5.15. Current day (CD)

Set the current day.



Note

The current day is defined from D1(Monday) to D7 (Sunday).

AP Press  or  to set the current day.

AQ Press  to validate the selection and move to the next parameter.



6.5.16. Flow meter type (FM)

Select the flow meter type.

Options:

- P0.7: ¾" paddle wheel meter;
- t0.7: ¾" turbine meter (Standard setting for 5800 SXT);
- P1.0: 1" paddle wheel meter;
- t1.0: 1" turbine meter;
- P1.5: 1½" paddle wheel meter;
- t1.5: 1½" turbine meter;
- P2.0: 2" paddle wheel meter;
- Gen: Generic or other non-Fleck meter.

AR Press ▼ or ▲ to select the flow meter type.

AS Press ↻ to validate the selection and move to the next parameter.

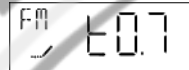

6.5.17. Meter pulse (K)

Set the meter pulse for a non-standard flow meter.



Note

The meter pulse parameter is only available if the Gen option has been set in flow meter type selection.

AT Press ▼ or ▲ to set the meter constant in pulses per unit of volume.

AU Press ↻ to validate the selection and move to the next parameter.

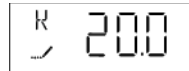

6.5.18. Time based relay setting (RE)

Select the relay setting.



Note

The relay can be set upon a time base (**tb**) or a flow base (**Fb**). Only one method can be used at a time.



Note

If set to **tb**, the controller will enable and disabled the relay output on set times.

AV Press ▼ or ▲ to select between **tb** and **OFF**.

AW Press ↻ to validate the selection and move to the next parameter.

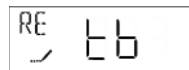

6.5.18.1 Relay start time (ST)

Set the relay start time.





Note

This option is available only if **RE** is set to **tb**.



Note

The relay start time can be set from 0 minute to the total of time of all the cycles minus 1 minute.

AX Press  or  to set the relay start time.

AY Press  to validate the selection and move to the next parameter.



6.5.18.2 Relay end time (ET)

Set the relay end time.





Note

This option is available only if **RE** is set to **tb**.



Note

The relay end time can be set from start time to the total of time of all the cycles.

AZ Press  or  to set the relay end time.

BA Press  to validate the selection and move to the next parameter.

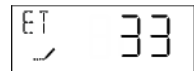

6.5.19. Flow based relay setting (VR)

Select the relay setting.



Note

The relay can be set upon a time base (**tb**) or a flow base (**Fb**). Only one method can be used at a time.





Note

This option is available only if **RE** is set to **OFF**.



Note

If set to **Fb**, the controller will enable and disabled the relay output every time the set volume interval is reached for the set time **ON**.

BB Press  or  to select between **Fb** and **OFF**.

BC Press  to validate the selection and move to the next parameter.

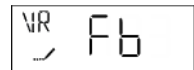

6.5.19.1 Relay volume interval (VO)

Set the relay volume interval.





Note

This option is available only if **VR** is set to **Fb**.



Note

The relay volume interval can be set from 1 to the total capacity in litres.

BD Press  or  to set the relay volume interval.

BE Press  to validate the selection and move to the next parameter.



6.5.19.2 Relay time ON (TO)

Set the relay time ON.





Note

This option is available only if **VR** is set to **Fb**.



Note

The relay time ON can be set from 1 to 7200 minutes.

BF Press  or  to set the relay time ON.

BG Press  to validate the selection and move to the next parameter.



6.6. Filter programming

To use the valve as a filter, in the master programming mode, set the regeneration mode (RF) to filter (FLtr). The controller will let set only the steps necessary to the filter mode, which are: regeneration control type (CT), days override (DO), regeneration time (RT), backwash (BW), rapid rinse (RR), day of week (Dn) and current day (CD).

6.7. Diagnostic



Note





Depending on current settings, some displays cannot be viewed.



Note

If none of the buttons are pushed for 1 minute in the diagnostic mode the controller returns to Service mode.

6.7.1. Commands

- A Press and hold  and  for five seconds to enter the diagnostic mode.
- B Press  or  to navigate in the diagnostic mode.
- C Press  to exit the Diagnostic mode at any time.

6.7.2. Current flow rate (FR)



Note

The display is updated every second.

- A Current flow rate display (L/min or gpm depending on display format programmed).

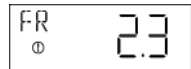

6.7.3. Peak flow rate (PF)



Note

The controller registers the highest flow rate (L/min) since the last regeneration.

- B Peak flow rate display:

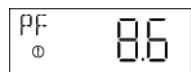

6.7.4. Hours since last regeneration (HR)



Note

Shows the number of hours since the last regeneration, indicating the length of the current service cycle.

- C Hours since last regeneration display:



6.7.5. Volume since last regeneration (VU)



Note

Shows the volume used since the last regeneration (L).

- D** Volume since last regeneration display (L or Gal depending on display format programmed).



6.7.6. Reserve capacity (RC)



Note

Shows the remaining reserve volume until next regeneration (L).

- E** Volume until next regeneration display (L or Gal depending on display format programmed).



6.7.7. Totalizer (TV)



Note

Shows the total volume used (L).

- F** Totalizer display (L or Gal depending on display format programmed).

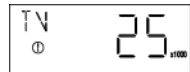

6.7.8. Software version (SV)



Note

Shows the version of the software used by the controller.

- G** Software version display:



6.8. Resetting the controller



Note



There are two methods to reset.

6.8.1. Soft reset (SR)



Caution

All the parameters are set to default values, except volume remaining in volumetric systems and days since last regeneration in time clock systems.

- A** Press and hold  and  for 25 seconds while in normal service mode until **SR** is displayed.

SR _ _ _ _

6.8.2. Hard reset (HR)



Caution

All the parameters are set to default values.

- A** Hold  while powering up the unit.
B The display shows **HR**.
C Reprogram all parameters in Master programming mode.

HR _ _ _ _

7. Commissioning



Note

This chapter is available for standard regeneration types. Contact your supplier if the actual regeneration is not standard and if you need assistance.

7.1. Water filling, draining and waterproofness inspection

7.1.1. Activating the softener

- A** With the bypass still in Bypass position (inlet and outlet of the valve closed), plug in the SXT controller to the power source.
- B** Proceed to programming according to your system specification if not done yet.
- C** Start a manual regeneration by pressing the regen button for 5 seconds. The piston will move into backwash position. If the first cycle is not backwash, quick cycle the valve until the piston is in backwash position. Once in this position, unplug the SXT controller from the power source.
- D** Open the nearest faucet close to the system.
The valve and tank will slowly get filled with raw water, allowing air to be purged by the drain and/or by the open faucet next to the system. Open the inlet progressively until fully open position.
- E** With the bypass still in bypass position, put the bypass slowly in service position.
- F** Once the drain runs clear and the bypass valve is fully in service position, plug in again the SXT controller to the power source.
- G** Push on the regen button once to move the piston to the next regeneration cycle position. Leave the valve 1 minute in each positions and move to the next one, until RF (brine refill cycle) is displayed. When RF is displayed, let the valve run the entire cycle and check the level of water in the brine tank or cabinet. The level of water in the brine tank should be about 5 cm above the salt platform. You may want to mark the level on the brine tank as this can be used as an indicator for the future lifetime of the softener.
- H** Once RF is completed, the valve will automatically go back into service position (unless non-standard regen sequence is programmed). Start again a manual regeneration by pressing for 5 seconds on the regen button. The valve will move to backwash position.
- I** Press the regen button once to move to brine draw position. Check to see in the brine tank if the water level decrease.
- J** Once the draw function is observed and confirmed (level of water in the brine tank or cabinet has decreased), you may go through each cycle pushing on the regen button until RF, leave the water come back to the 'full' level, and then push on the regen button so that the valve returns into service position.
- K** Fill the brine tank or cabinet with salt. You may want to mark the level of water in the brine tank/ cabinet when completely refilled with water and full of salt. In the future, after each regeneration, you can visually control that the quantity of water refilled should be between the 2 marks done. Marking are optional, but may allow to visually detect any irregularity during regeneration that may lead to softener inefficiency.
- L** With the brine tank completely refilled and full of salt, adjust the safety brine valve in the brine well. Make sure the overflow elbow is installed above the float level.
- M** After the softener has been running a few minutes in service, proceed to hardness test on outlet water to make sure the water is treated as per requirements.

The system is ready and in service

7.1.2. Additional tips

You can start programming from the beginning by resetting the amount of media, see chapter 6.8. Resetting the controller, page 63.

7.2. Sanitization

7.2.1. Disinfection of water softeners

The materials of construction of the modern water softener will not support bacterial growth, nor will these materials contaminate a water supply. In addition, during normal use, a softener may become polluted with organic matter, or in some cases with bacteria from the water supply. This may result in an off-taste or odor in the water.

Thus, your softener may need to be disinfected after installation. Some softeners will require periodic disinfection during their normal lifetime. Consult your installing dealer for more information on disinfecting your softener.

Depending on the conditions of use, the softener type, the type of ion exchanger, and the disinfectant available, a choice can be made among the following methods.

7.2.2. Sodium or calcium hypochlorite

These materials are satisfactory for use with polystyrene resins, synthetic gel zeolite, greensand and bentonites.

5.25% Sodium hypochlorite

If stronger solutions are used, such as those sold for commercial laundries, adjust the dosage accordingly.

Dosage

Polystyrene resin: set 1.25 mL fluid per 1 L of resin.

Non-resinous exchangers: set 0.85 mL fluid per 1 L.

Brine tank softeners

Backwash the softener and add the required amount of hypochlorite solution to the well of the brine tank. The brine tank should have water in it to permit the solution to be carried into the softener.

Proceed with the normal regeneration.

Calcium hypochlorite

Calcium hypochlorite, 70% available chlorine, is available in several forms including tablets and granules. These solid materials may be used directly without dissolving before use.

Do not let the disinfectant stand for more than 3 hours in the brine tank before the regeneration start.

Dosage

Measure two grains ~ 0.11 mL for 1 L.

Brine tank softeners

Backwash the softener and add the required amount of hypochlorite to the well of the brine tank. The brine tank should have water in it to permit the chlorine solution to be carried into the softener.

Proceed with the normal regeneration.

7.2.3. Electro chlorination

Valves or systems already equipped with an electrochlorinator device or system will be sanitized during the brine draw phase.

Wrekin

8. Operation

8.1. Display during operation

Examples:

- Valve in service with day time:



- Valve in service with volume remaining before regeneration:



- Remaining days before next regeneration:



- In volumetric regeneration mode, reserve 1223 litres remaining:

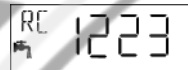

- In volumetric regeneration mode, exhausted reserve, immediate or delayed start in regeneration depending on the adjustment:

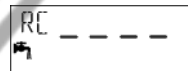

Note

In delayed volumetric mode, the icon  flashes as soon as the reserve begins to be used.

8.1.1. During regeneration

During a regeneration the display shows the current cycle step and the time remaining for that cycle. The countdown for the time remaining starts only when the valve is in the cycle displayed.

Examples

- Refill cycle, 12 min 38 sec. left:

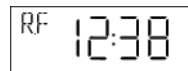

- Rapid rinse cycle, 2 min 17 sec. left:

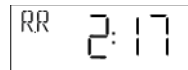

8.2. Recommendations

- Use only regeneration salts designed for water softening upon regulation EN973.
- For optimal system operation, the use of clean salt and impurities free is recommended (for example salt pellets).
- The sanitizing process (both with liquid and electrochlorination) may introduce chlorine compounds which may reduce the lifetime of the ion exchange resins. Refer to the technical guides for resins in common use, providing necessary checks on the system.

8.3. Manual regeneration

**Mandatory**

The controller must be in service in order to enable this procedure.

8.3.1. Manual delayed regeneration

- A Press  once for delayed regeneration.
- The regeneration starts at the programmed regeneration time. See chapter 6.5.12. Regeneration time (RT), page 56.
 - The service icon flashes.
-

**Note**

To cancel: press  again. The service icon stop flashing.

8.3.2. Immediate regeneration

- A Press and hold  for 5 seconds to initiate immediate manual regeneration regardless from the programmed regeneration control type.

8.3.3. To advance regeneration cycles

- A Press  to pass to the next regeneration cycle.
-

8.4. Operation during a power failure

- Current valve position, cycle step time elapsed, and time of day is stored 24 hours during a power failure, and will be restored upon power restoration.
 - In regeneration, when power is shutting down, the controller saves the current regeneration data. When power is restored, the controller resume the regeneration cycle at the point where power failed.
-

**Caution**

Without power, the valve stay in its current position. The system should include all required safety components to prevent overflows.

- All the program settings are stored in a permanent memory.
- Time is kept during a power failure and the time of day is adjusted upon restoration of the power (as long as the power is restored within 24 hours).
- The time of day on the main display screen will flash when there has been a power failure.
- The flashing of the time of day can be stopped by pressing any button on the display.

9. Maintenance



Mandatory

Cleaning and maintenance shall take place at regular intervals in order to guarantee the proper functioning of the complete system, and be documented in the Maintenance chapter in the User Guide document.

9.1. Recommendations

9.1.1. Use original spare parts



Caution

To ensure correct operation and safety of the device, only use original spare parts and accessories recommended by the manufacturer.
Usage of non-genuine spare parts void all warranties.

Parts to keep in stock for potential replacements are the pistons, S&S kit, injectors, optical sensor and motors. Refer to maintenance sheet.

9.1.2. Use original approved lubricants

- Dow Corning #7 Release Agent

9.1.3. Maintenance instructions

- Disinfect and clean the system at least once a year or if the treated water has an off-taste or an unusual odor.
- Perform a hardness test every year of both inlet and treated water.

9.2. Cleaning and maintenance

9.2.1. Cleaning and maintenance

Before any cleaning or maintenance procedure, complete the following steps:

No.	Operation
 Caution	These operations need to be performed before any cleaning or maintenance procedure.
A	Unplug the wall-mounted transformer.
B	Shut off water supply or put bypass valve(s) into bypass position.
C	Relieve system pressure before performing any operations.

9.2.2. Replacing the controller

No.	Operation
A	Press the cover clips (2) on each side and open the cover (1).
B	Press the board clips (3) and release the controller (4).
C	Disconnect the old controller.
D	Connect the new controller, see 5.8. Electrical connections, page 42.
E	Reverse above procedure steps to rebuild.

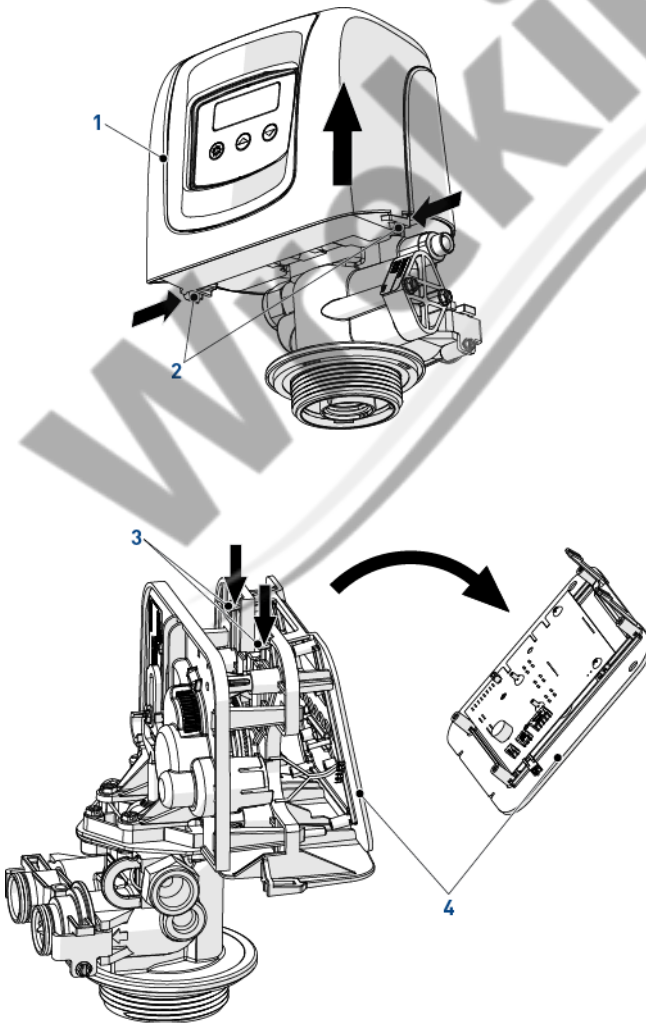

9.2.3. Replacing the controller motor

No.	Operation
A	Remove the controller, see 9.2.2. Replacing the controller, page 70.
B	Disconnect the optical sensor (3) .
C	Disconnect the motor.
D	Open the motor clips (1) and pull out the old motor (2) .
E	Change the motor (2) .
F	Reverse above procedure steps to rebuild.

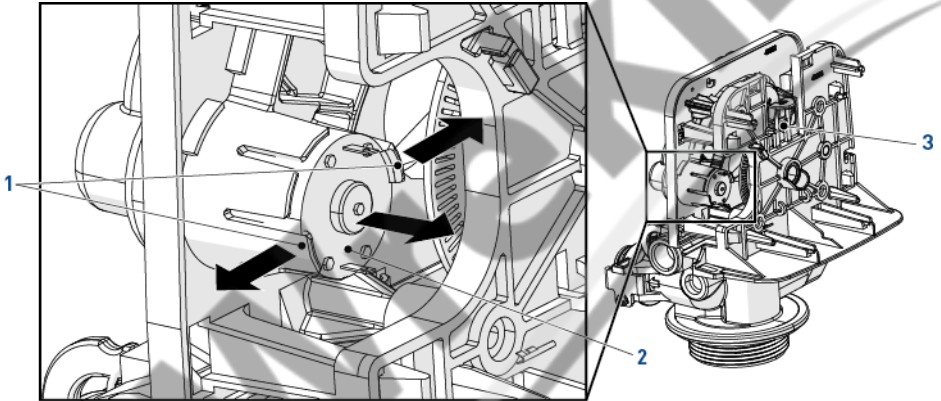

9.2.4. Replacing the gearing system

No.	Operation
A	Remove the controller, see 9.2.2. Replacing the controller, page 70.
B	Using a 6 mm wrench or flat screwdriver, unscrew (2).
C	Using a 8 mm wrench or flat screwdriver, unscrew (1).
D	Separate the gearing system (3) from the valve body (4).
E	Change the gearing system (3).
F	Reverse above procedure steps to rebuild. Mind the core marker and align the small holes of the gears for easy reassembly.



Caution

When assembling the gearing system (3) on the valve body (4), make sure to put the brighter part of the piston axle (5) on the left as shown below.



Tip

These operations need to be performed before any cleaning or maintenance procedure.

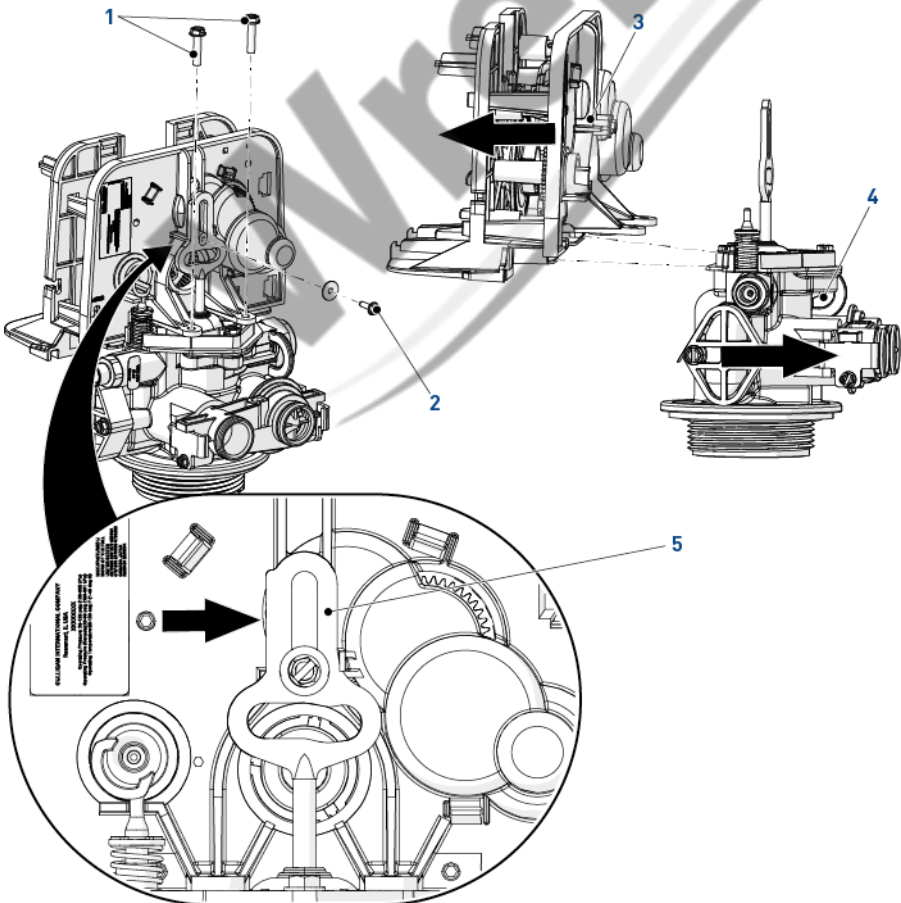

9.2.5. Replacing the piston and/or the brine valve

No.	Operation
A	Remove the gearing system, see "Replacing the gearing system", page 72.
B	Remove the screws (1).
C	Remove the piston and the piston cover (2) by pulling the piston cover on the points indicated by arrows.
D	Remove the o-ring (4).
E	Remove the brine valve (5).
F	Change the piston (3) and/or the brine valve (5).
G	Lubricate the o-ring (4) with approved silicon grease.
H	Reverse above procedure steps to rebuild.

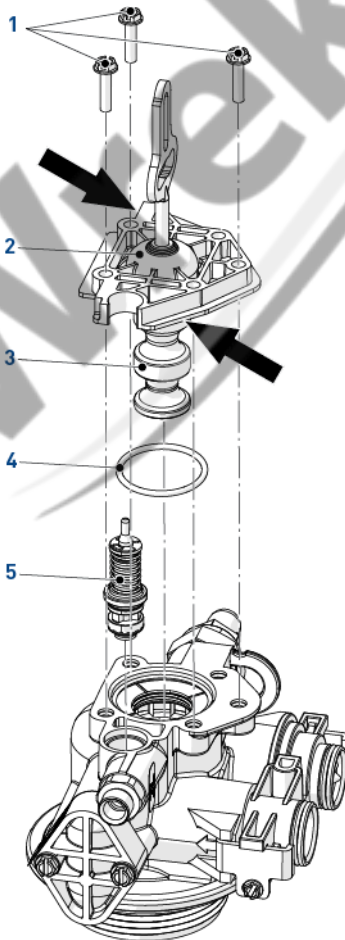

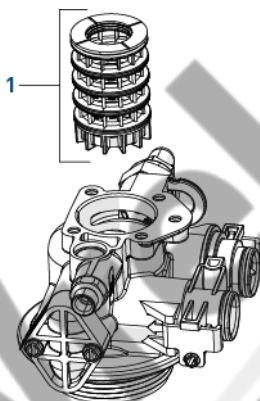

9.2.6. Replacing the seals and spacers cartridge

No.	Operation
A	Remove the piston, see "Replacing the piston and/or the brine valve", page 73.
B	Remove the seals and spacers cartridge (1).
C	Change the seals and spacers cartridge (1).
D	Lubricate the seals and spacers cartridge (1) with approved silicon grease.
E	Reverse above procedure steps to rebuild.



9.2.7. Cleaning the injector

No.	Operation
A	Remove the screws (4).
B	Remove the cap injector (3).
C	Remove the seal (5) taking note of its position.
 Caution	Depending of configuration, the position of the seal can be different as shown. The mid part of the seal should be aligned with the position of the injector.
D	Using the pusher (2), remove the injector (1).
 Caution	To avoid any damage on the injector, use only the pusher to remove it.
E	Remove the screen (7).
F	Remove the injector plug (6).
 Note	The plug has 2 slots in at the top. The plug can be removed by hooking something into one of these slots from the center of the plug.
G	Clean or change the injector (1), the screen (7), the injector plug (6) and the seal (5).
H	Lubricate all seals with approved lubricant only.
I	Reverse above procedure steps to rebuild.

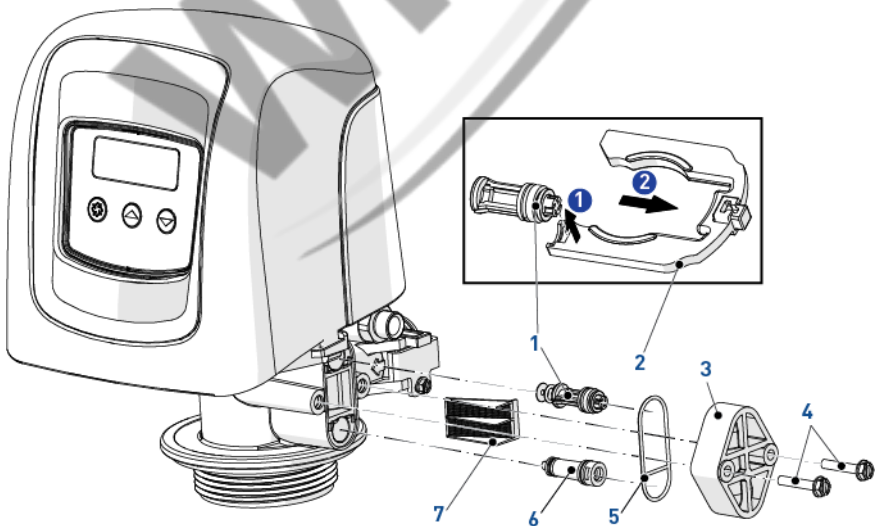

9.2.8. Replacing the optical sensor

No.	Operation
A	Remove the controller, see 9.2.2. Replacing the controller, page 70.
B	Disconnect the wire from the motor to the optical sensor (4).
C	Release the optical sensor support (1) by pushing it back and up as shown.
D	Release the optical sensor (3) from its support (1) by pressing the clips (2).
E	Change the optical sensor (3).
F	Reverse above procedure steps to rebuild.

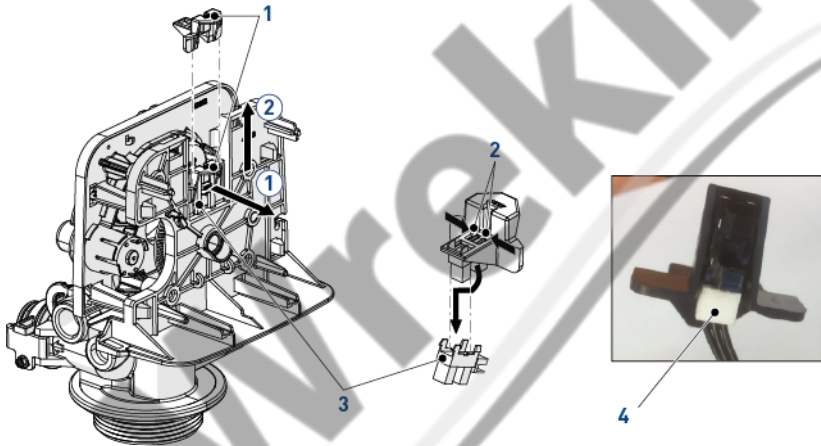

10. Troubleshooting

Problem	Cause	Solution
Water softener fails to regenerate automatically.	Cord plugged into intermittent or switched off power source.	Connect to constant power source.
	Disconnected / faulty meter cable.	Reconnect / replace cable.
	Defective power cord.	Replace cord.
	Defective timer, meter or sensor.	Replace or repair.
	Bad programming.	Program correctly.
Regeneration at wrong time.	Timer improperly set, due to power failure.	Reset timer.
Loss of capacity.	Increased raw water hardness.	Reset unit to the new capacity.
	Brine concentration and/or quantity.	Keep brine tank full of salt at all times. Clean it yearly. Salt may be bridged. If using a salt grid plate ensure refill water is over it.
	Resin fouling.	Call dealer, find out how to confirm it, clean the resin and prevent future fouling.
	Poor distribution, Channeling (uneven bed surface).	Call dealer. Check distributors and backwash flow.
	Internal valve leak.	Call dealer. Replace spacers, seals and/or piston.
	Resin age.	Call dealer. Check for resin oxidation caused by Chlorine. Mushy resin.
	Resin Loss.	Call dealer. Check for correct bed depth. Broken distributors.
Poor water quality.	Check items listed in loss of capacity.	
	Bypass valve open.	Close by-pass valve.
	Channeling.	Check for too slow or high service flow. Check for media fouling.
	Mixing wrongly set.	Set mixing correctly.
High salt usage.	High salt setting.	Adjust salt setting.
	Excessive water in brine tank.	See problem "Excessive water in brine tank".
Loss of water pressure.	Scaling/Fouling of inlet pipe.	Clean or replace pipeline. Pretreat to prevent.
	Fouled resin.	Clean the resin. Pretreat to prevent.
	Improper backwash.	Too many resin fines and/or sediment. Call dealer, reset backwash flow rate, and/or adjust time.

Problem	Cause	Solution
Excessive water in brine tank and/or salty water to service.	Plugged Drain Line.	Check flow to drain. Clean flow control.
	Dirty or damaged brine valve.	Clean or replace brine valve.
	Plugged injector.	Clean injector and replace screen.
	Low inlet pressure.	Increase pressure to allow injector to perform properly (1.4 bar minimum).
	Timer not cycling.	Replace timer.
Softener fails to use salt.	Plugged/restricted drain line.	Clean drain line and / or flow control.
	Injector is plugged.	Clean or replace injector and screen.
	No water in brine tank.	Check for restriction in BLFC. Ensure safety float is not stuck.
	Water pressure is too low.	Line pressure must be at least 1.4 bar.
	Brine line injects air during brine draw.	Check brine line for air leaks.
	Internal valve leak.	Call dealer. Check piston, seals and spacers for scratches and dents.
Valve cycles continuously.	Faulty controller.	Replace controller.
Continuous flow to drain.	Foreign material in control valve.	Call dealer. Clean valve, rebuild unit.
	Internal control valve leakage.	
	Valve jammed in brine or backwash position.	
	Motor stopped or jammed during regeneration.	Replace motor.

10.1. Error detection

Errors codes appear on the service display.



Note

It can take up to 1 minute before an error can be detected and displayed.

10.2. Error types and causes

10.2.1. Motor stall / cam sense error



Note

No states changes in the optical sensor detected for six seconds.

- A** Unplug the unit and plug back in. Allow the controller to attempt to find position again.
- B** If the unit doesn't find position, unplug, open the cover (see "Replacing the controller", page 70) and verify the optical sensor is in place with the wires connected to the circuit.
- C** Verify the motor and gearing components are in good condition and assembled properly.
- D** Check the valve and verify that the piston travels freely.
- E** Replace / reassemble the various components as necessary.
- F** Plug the unit back in and observe its behaviour.
- G** If the error reoccurs, unplug the unit.
- H** Put it into bypass.
- I** Contact dealer.



10.2.2. Motor run-ON error / cycle sense error



Note

An undesired optical sensor state change occurred.

- A** Non critical error, extra optical sensor pulse detected.
- B** Press any button to clear the error.
- C** Press  to advance motor to clear error.



10.2.3. Regeneration failure



Note

The system has not regenerated for more than 99 days or 7 days if the controller type has been set to day of week.

- A** Perform a manual regeneration to reset the error code.
- B** If the system is metered, verify that it is measuring flow by running service water and watching for the flow indicator on the display.
- C** If the unit doesn't measure flow, verify that the meter is working properly and its cable is well connected.
- D** Enter master programming mode.
- E** Verify that the unit is configured properly.
- F** Check that system capacity has been selected.
- G** Check that day override is set properly.
- H** Check that meter is identified correctly.
- I** If the unit is configured as a day of week system, verify that at least one day is set ON.
- J** Correct the setting as necessary.



10.2.4. Memory error



Note

The controller board has a memory failure.

- A** Perform a master reset.
- B** Reconfigure the system via master programming mode.
- C** Step the valve through a manual regeneration.
- D** If the error reoccurs, unplug the unit.
- E** Put it into bypass.
- F** Contact dealer.



10.2.5. Fail safe error



Note

The valve has failed to find position in one minute.

- A** Unplug the unit and plug back in.
- B** If the error reoccurs, unplug the unit.
- C** Put it into bypass.
- D** Contact dealer.

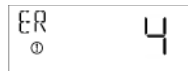

11. Spare parts

11.1. Plastic turbine meter assembly

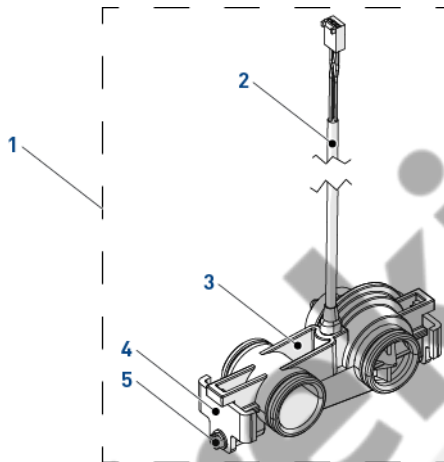

Item	Part number	Description	Packaging quantity
1	60626-01	Meter turbine assembly 3/4" SXT	1
2	BR19791-01	Meter cable turbine assembly	1
3	19797	Meter turbine assembly 5800	1
4	BU19569	Clip	2
5	13314	Screw	2

11.2. Valve parts list

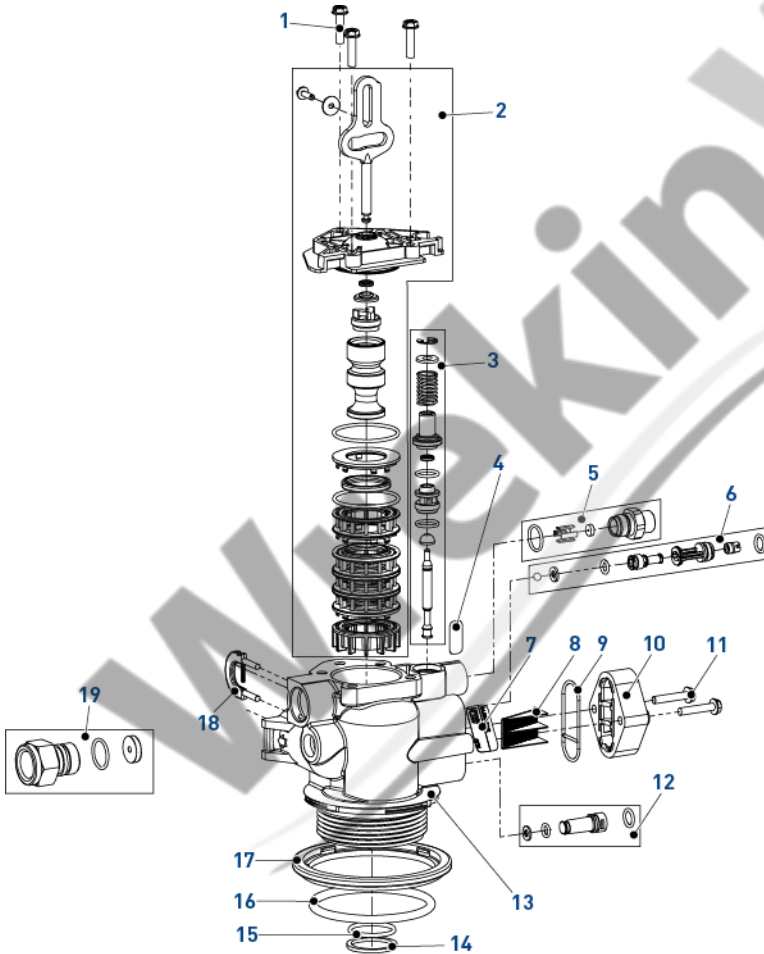

Item	Part number	Description	Packaging quantity
1	18261	Screw, hex washer head, #10-24 x 0.81"	3
2	BR61837	Piston and seal kit assembly, downflow 5800	1
-	BR61838	Piston and seal kit assembly, upflow 5800	1
3	60032	Brine valve 4600 / 5600	1
4	13333	Label, injector blank	1
5	18332-0.12	BLFC, 0.125_gpm, 5000 / 5600 / 9000	1
-	18332-0.25	BLFC, 0.25_gpm, 5000 / 5600 / 9000	1
-	18332-0.50	BLFC, 0.50_gpm, 5000 / 5600 / 9000	1
-	18332-1	BLFC, 1.00_gpm, 5000 / 5600 / 9000	1
6	18272-000	Injector assembly, 1610, #000, brown	1

Item	Part number	Description	Packaging quantity
-	18272-00	Injector assembly, 1610, #00, violet	1
-	18272-0	Injector assembly, 1610, #0, red	1
-	18272-1	Injector assembly, 1610, #1, white	1
-	18272-2	Injector assembly, 1610, #2, blue	1
-	18272-3	Injector assembly, 1610, #3, yellow	1
7	10759	Label 0.5 gpm_1.5 lbs salt/min	1
8	18271	Screen injector 5000	1
9	18301	Seal injector	1
10	18277	Cap injector	1
-	18278-20	Injector cap assembly, 1650 regulated, 5000, 20 psi, upflow	1
-	18278-30	Injector cap assembly, 1650 regulated, 5000, 30 psi, upflow	1
11	18262	Screw, hex washer head, #10-24 x 1"	2
12	18276-01	Injector assembly, plug with o-rings	1
13	BR61857-01	Valve body assembly 5800 Filter (includes items 14,15 16,17 and 18)	1
-	BR61857-20	Valve body assembly 5800 w/mixing (includes items 14,15 16,17 and 18)	
14	BR13030	Retainer, distributor tube o-ring	1
15	13304-01	O-ring-560CD	1
16	18303-01	O-ring top of the tank	1
17	18569	Retainer, tank seal	1
18	18312	Retaining clip drain	1
19	24078-EMPTY	DFLC, plastic, blank & hose barb bent	1
-	24078-0.8	DFLC, plastic, 0.80 gpm & hose barb bent	1
-	24078-1	DFLC, plastic, 1.0 gpm	1
-	24078-1.2	DFLC, plastic, 1.2 gpm& hose barb bent	1
-	24078-1.5	DFLC, plastic, 1.5 gpm& hose barb bent	1
-	24078-2	DFLC, plastic, 2.0 gpm& hose barb bent	1
-	24078-2.4	DFLC, plastic, 2.4 gpm& hose barb bent	1
-	24078-3	DFLC, plastic, 3.0 gpm& hose barb bent	1
-	24078-3.5	DFLC, plastic, 3.5 gpm& hose barb bent	1
-	24078-4	DFLC, plastic, 4.0 gpm& hose barb bent	1
-	24078-5	DFLC, plastic, 5.0 gpm& hose barb bent	1
-	24078-6	DFLC, plastic, 6.0 gpm& hose barb bent	1
-	24078-7	DFLC, plastic, 7.0 gpm& hose barb bent	1
-	26147-8	DFLC, 1" assembly 8 gpm	
-	26147-9	DFLC, 1" assembly 9 gpm	
-	26147-10	DFLC, 1" assembly 10 gpm	1
-	26147-12	DFLC, 1" assembly 12 gpm	1

Item	Part number	Description	Packaging quantity
-	26147-15	DFLC, 1" assembly 15 gpm	1
Not shown	40947-01	Plug, brine valve with o-ring 560 CD	1
Not shown	26958	BLFC module plug assembly with o-ring	1

11.3. Power head parts list

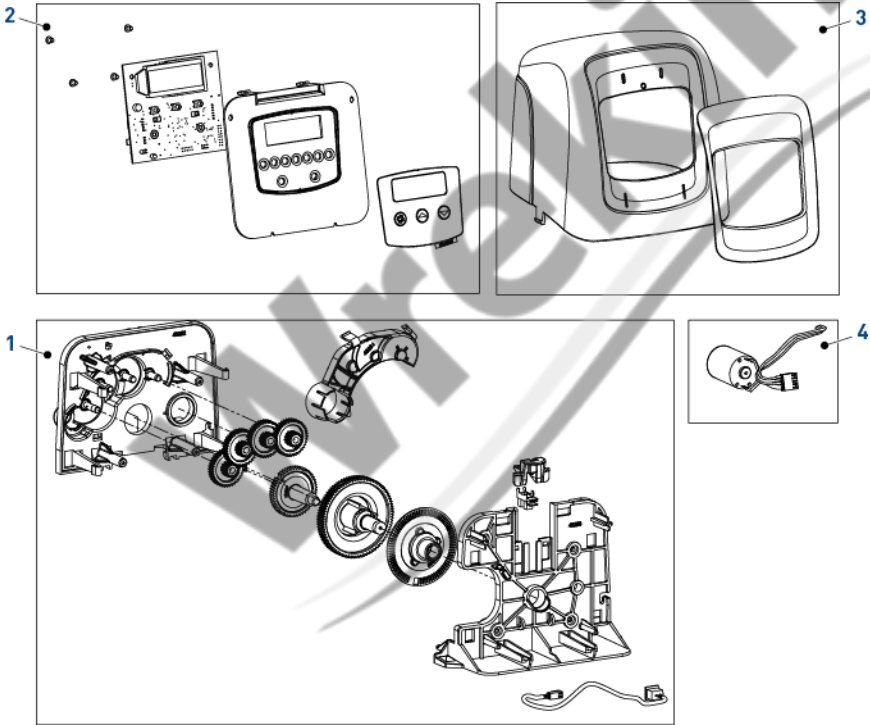

Item	Part number	Description	Packaging quantity
1	BR61836	Panel gear assembly, downflow / upflow	1
2	BR61834	Controller SXT assembly	1
3	BR61832-00	Cover assembly, black / blue	1
4	BR61835	Motor assembly	1

11.4. Bypass valve assembly list

11.4.1. Plastic bypass (no yoke)

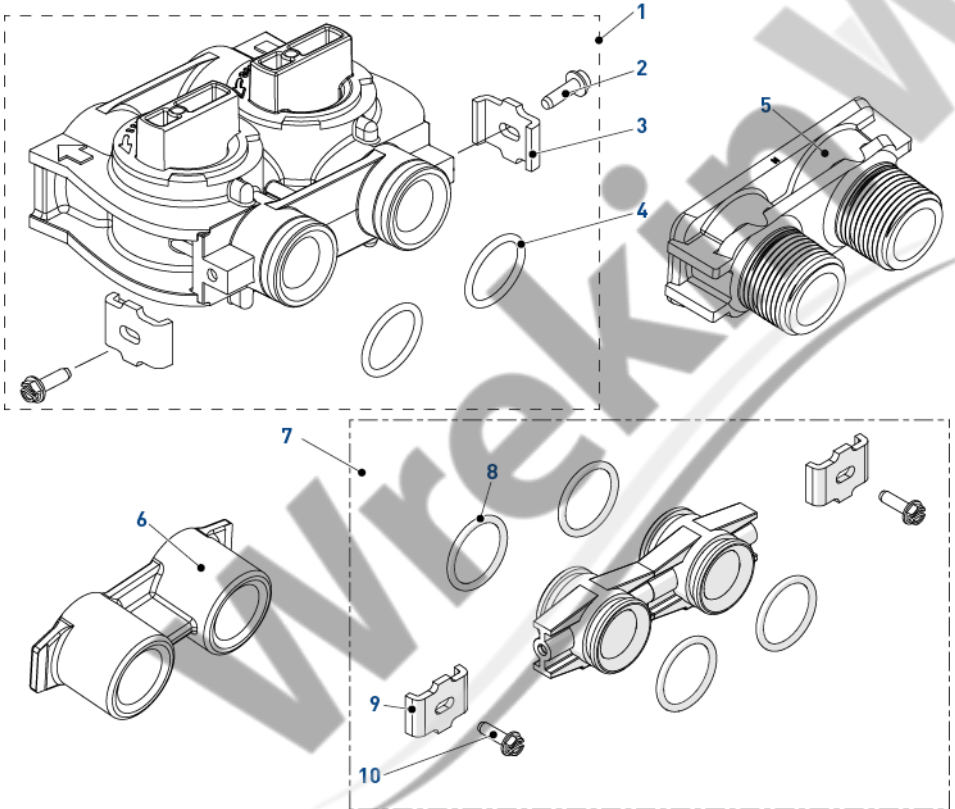

Item	Part number	Description	Packaging quantity
1	BU26054	Bypass plastic	1
2	13314	Screw, slot ind, hex, 8-18 x 0.60"	2
3	BU13255	Clip mounting	2
4	13305	O-ring-119	2
5	18706-10	Yoke, 1", BSP, male, plastic	1
-	18706-12	Yoke, 3/4", BSP, male, plastic	1
	24689	Yoke, 3/4", BSP, male, brass	1
6	13398-10	Yoke 1", BSP, Female, Brass	1
7	Kit 256	Adapter assembly, kit coupling, with o-rings	1
8	13305	O-ring-119	10
9	BU13255	Clip mounting	10
10	13314	Screw, slot ind, hex, 8-18 x 0.60"	10

11.4.2. 1" BSP female stainless steel bypass

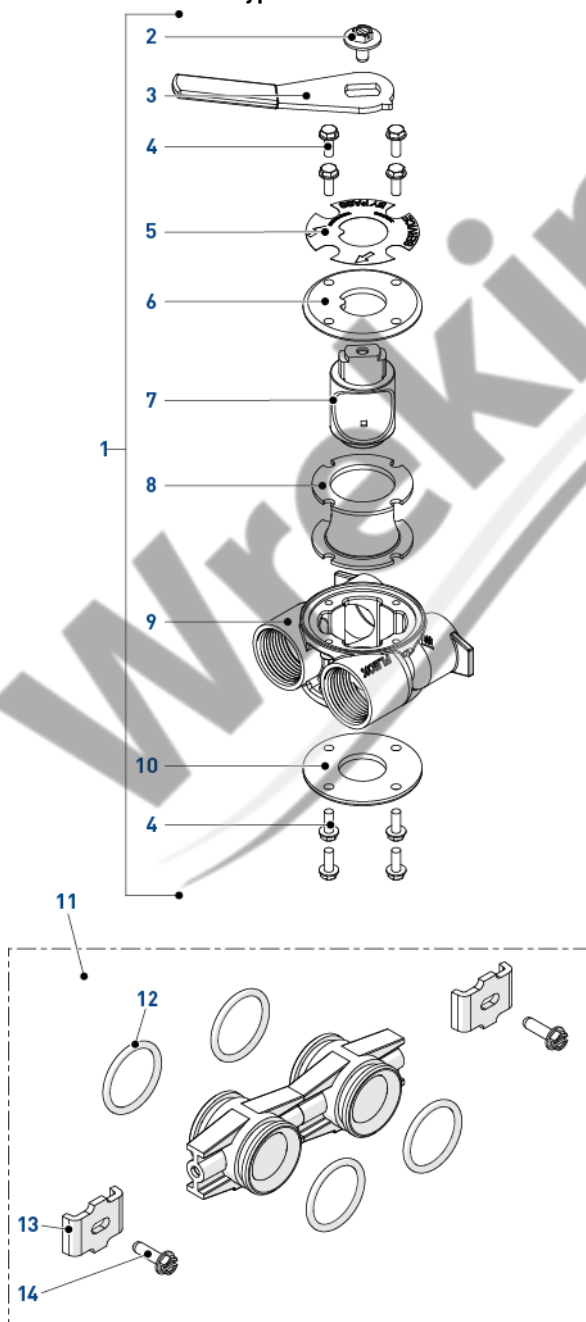

Item	Part number	Description	Packaging quantity
1	BU28502	Bypass Stainless Steel 1" BSP	1
2	13386	Screw Hex Hd Mach 1/4-20 X 1 Or Slot Hex	1
3	24419-10	Bypass handle red	1
4	15727	Screw, Hex washer head 10-24 x 0.5"	8
5	13604-01	Label bypass standard	1
6	BU11978	Cover bypass, Top	1
7	BU11972	Plug, bypass	1
8	14105	Seal, bypass, 560CD	1
9	40634-10	Bypass body, 1" BSP, stainless steel	1
10	11986	Cover bypass, Bottom	1
11	Kit 256	Adapter assembly, kit coupling, with o-rings	1
12	13305	O-ring-119	10
13	BU13255	Clip mounting	10
14	13314	Screw, slot ind, hex, 8-18 x 0.60"	10

11.5. Safety brine valve

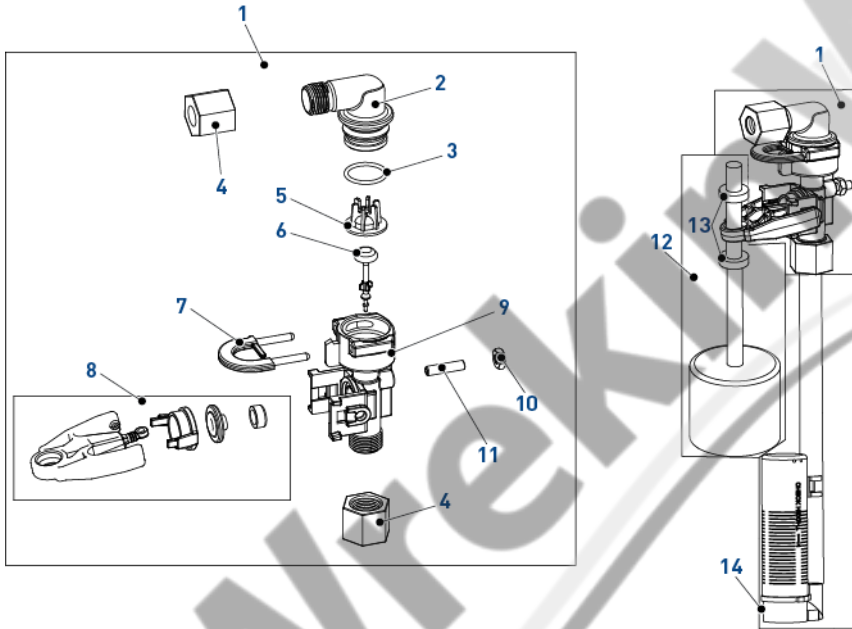

Item	Part number	Description	Packaging quantity
1	60014	Safety brine assembly, 2310	1
2	26746	Elbow assembly, safety brine valve	1
3	11183	O-ring-017	1
4	19625	Brine Valve 1650 Plastic Nut assembly	2
5	19649	Flow disperser	1
6	PWG19652-01	Poppet assembly, SBV, with o-ring	1
7	18312	Retainer, drain	1
8	PWG19803	Safety brine valve arm assembly	1
9	19645	Body, safety brine valve, 2310	1
10	19805	Plastic SBV 2310 Nut	1
11	19804	Screw, sckt Hd, set, 10-24 x 0.75"	1
12	60068-30	New Float assy 2310	1
13	10150	Grommet pass rod 2300/2310/ 2350	2
14	18168	Air Check 500 (0,915 m)	1

Item	Part number	Description	Packaging quantity
-	26773	Air Check 500 (1,25 m)	1
-	23473	Air Check 500 (0,915 m) HW	1

11.6. Safety brine valves list

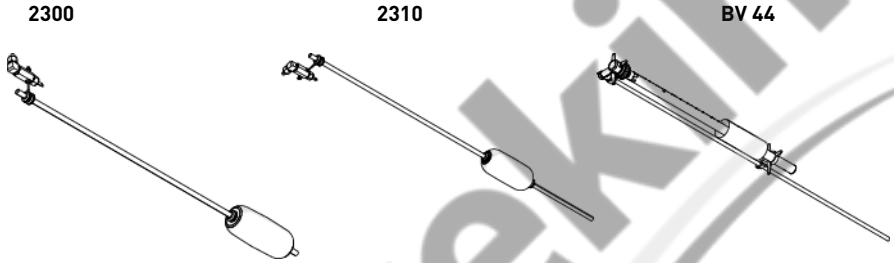

Item	Brine System	Part number	Description	Packaging quantity
-	1600	27833	Safety Brine Valve 2300 - Without Air-Check	1
-		27834	Safety Brine Valve 2300 - HW - Without Air-Check	1
-		60067-03	Safety Brine Valve 2310 - Without Air-Check	1
-		25687	Brine Valve 44 - 914mm	1
-		18961	Brine Valve 44 - 1250mm	1

12. Scrapping

The device must be scrapped in accordance with directive 2012/19/EU or the environmental standards in force in the country of installation. The components included in the system must be separated and recycled in a waste recycling center that conforms with the legislation in force in the country of installation. This will help to reduce the impact on the environment, health, safety and help to promote recycling. Pentair does not collect used product for recycling. Contact your local recycling center for more information.



Wrekin Wrekin Wrekin

PAGE INTENTIONALLY LEFT BLANK

A large, semi-transparent watermark logo for Wrekin Water is positioned diagonally across the upper right portion of the page. The logo features the word "Wrekin" in a bold, sans-serif font, with a stylized wave graphic underneath it. The background of the entire page is a solid blue color with a repeating pattern of light blue diamond shapes on the left side.

Wrekin

www.pentiraquaeurope.com